

Monteringsanvisning

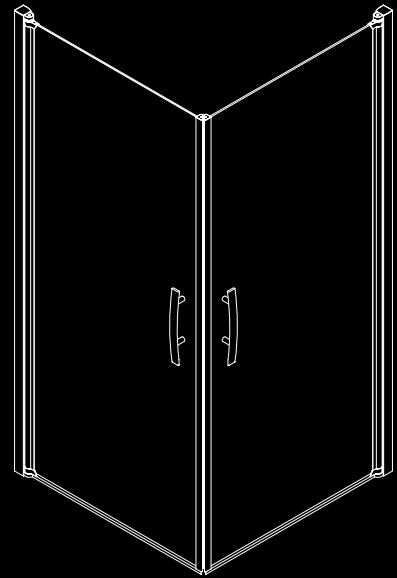

DALARÖ
SQUARE
80x80x195cm
90x90x195cm

DALARÖ

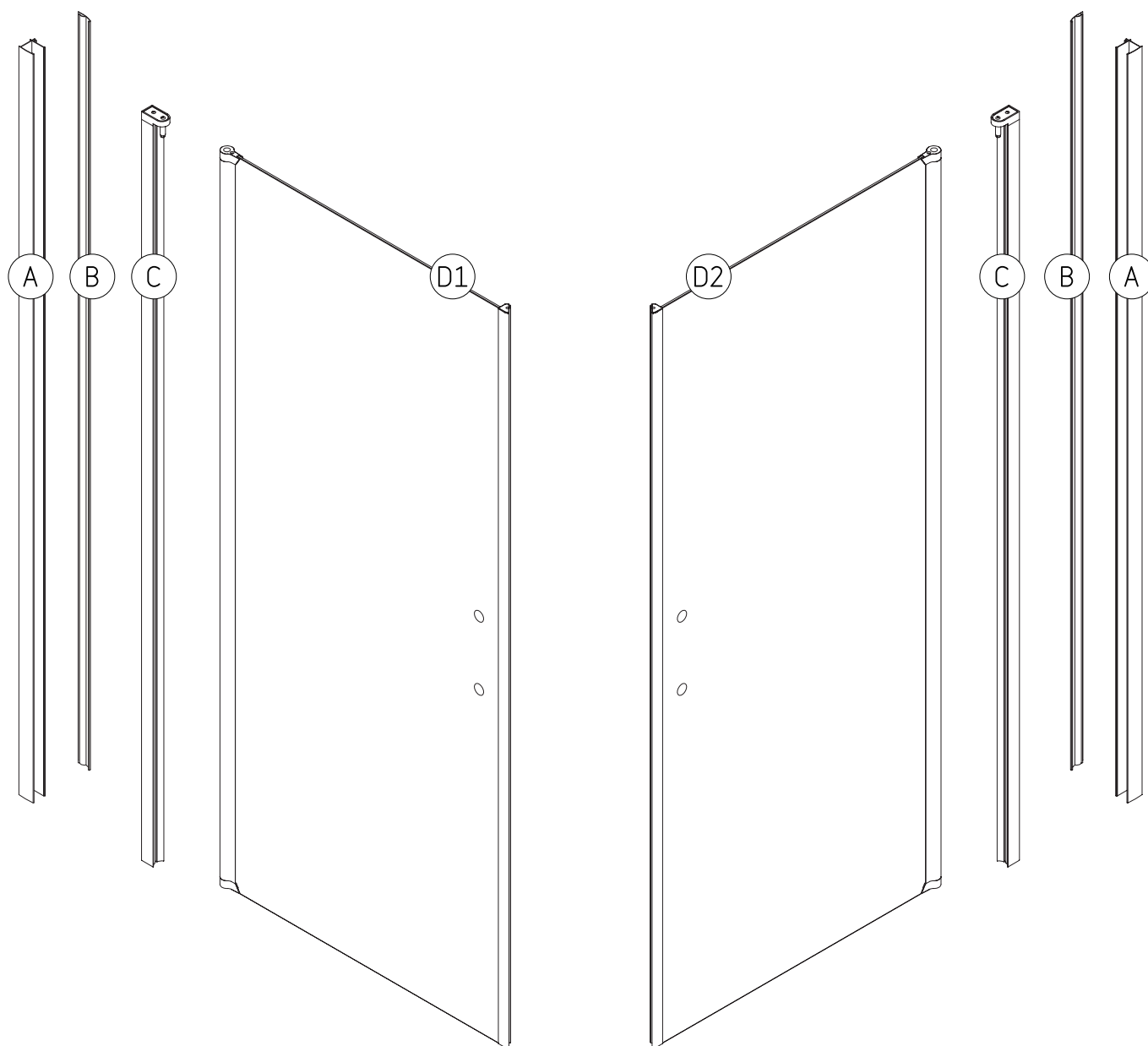

S Tack för att du har köpt en Camargue® produkt. Av säkerhetsskäl ber vi dig att läsa igenom denna installations- och bruksanvisning noggrant innan du installerar och använder produkten. Vi försökte packa upp och transportera allt på det bästa möjliga sättet men om du hittar någon skadad del eller om en del saknas behöver du inte gå tillbaka till butiken där du köpte varan. För den snabbaste lösningen kontakta oss direkt!

DK Tak fordi du har købt et Camargue® produkt. Af sikkerhedsmæssige grunde beder vi dig om at læse denne installations og brugsanvisning grundigt igennem inden du installerer og anvender produktet. Vi har forsøgt at pakke og transportere produktet på den bedst mulige måde, men hvis der mangler dele i kassen eller nogle dele er skadet, bør du ikke gå tilbage til butikken hvor du har købt produktet. For den hurtigste løsning kontakt os direkte!

DALARÖ SQUARE 80x80x195cm

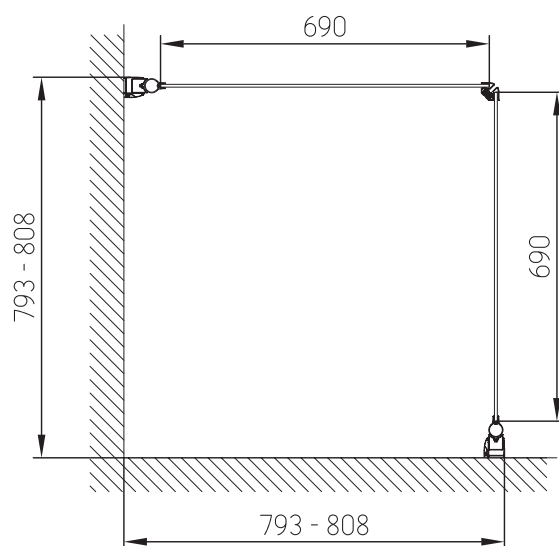

DALARÖ SQUARE 90x90x195cm

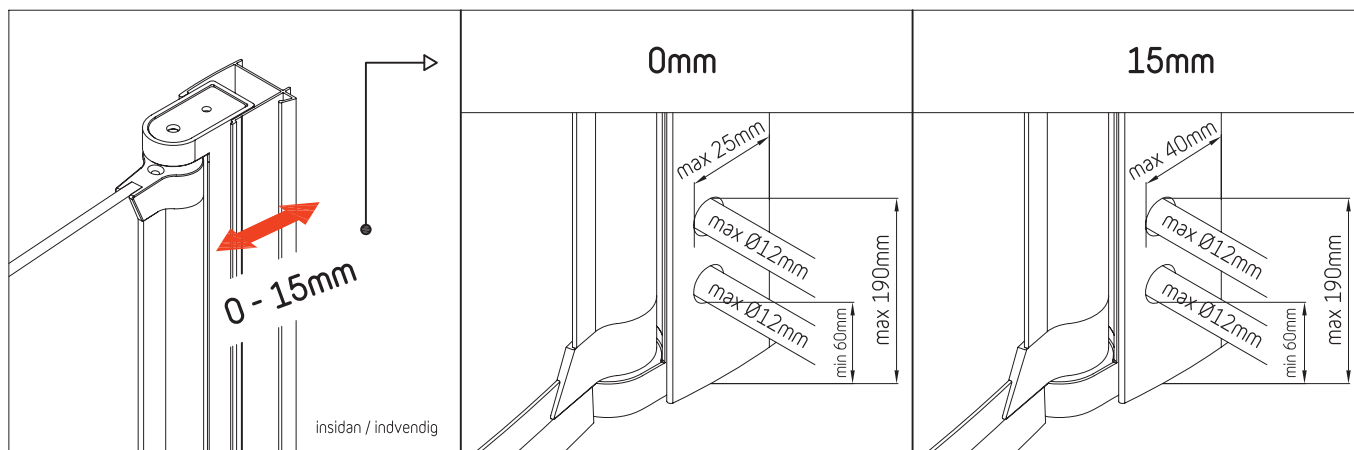
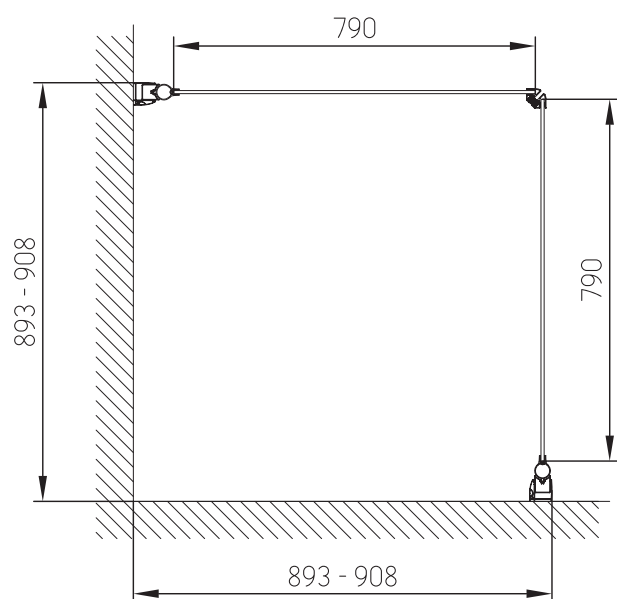

DALARÖ

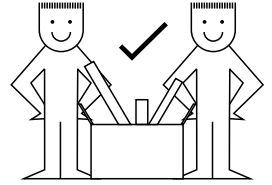
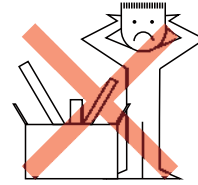

Delar / Dele

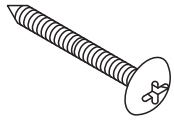

① 10 x (Ø5x40mm)



② 10 x (Ø4x12mm)

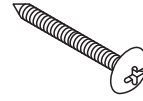

③ 2 x (Ø4x55mm)



④ 2 x



⑤ 2 x

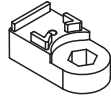

⑥ 2 x



⑦ 2 x

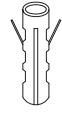

⑧ 10 x (Ø8x40mm)

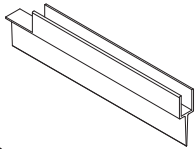

⑨ 2 x



⑩ 2 x

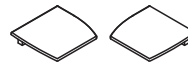

⑪ 2 x



⑫ 1 x



⑬ 10 x

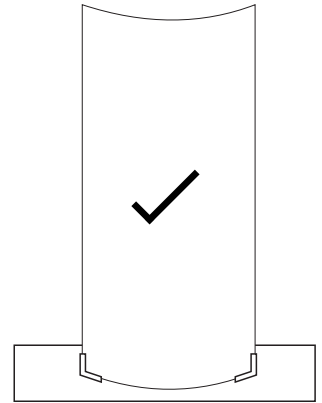
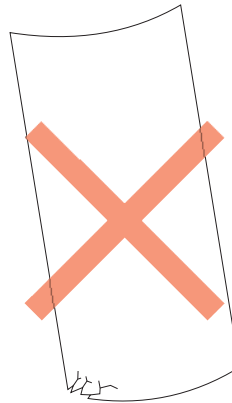
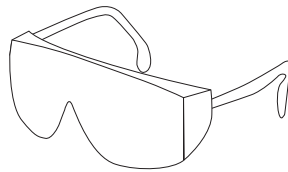

Verktøy / Værktøj

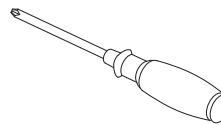
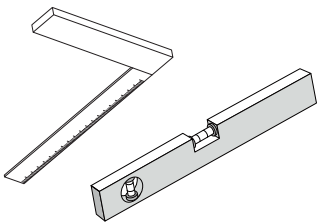

Ø3,2mm
Ø8mm

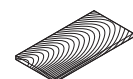
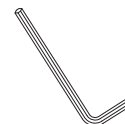
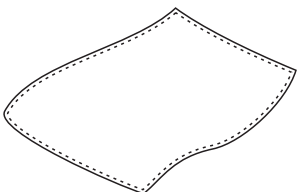
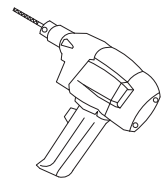

träblock / træklods

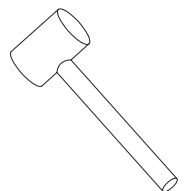

1

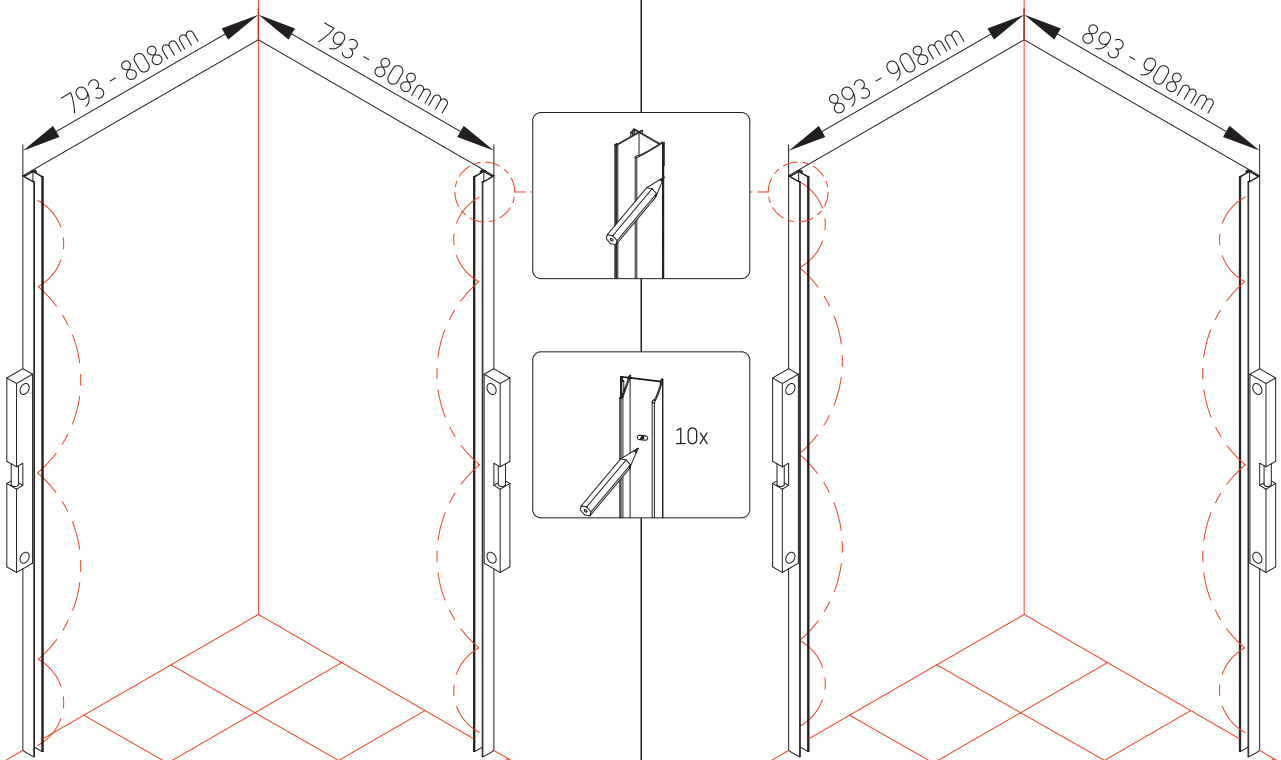

80x80x195cm

90x90x195cm

S VIKTIGT: Använd den bilden ovan som passar till den duschkörna som du har köpt. Lägg märke till att det visas 2 varianter duschkörna i manualen och var noga med att använda den bilden som passar din duschkörna. Leverantören är inte ansvarig för skador som uppstår i samband med felborrade hål.

DK VIKTIGT: Brug den tegning herover, der passer til det brusehjørne du har købt. Bemærk at der er vist 2 størrelser i denne manual, og du skal bruge den der passer til det produkt du har købt. Leverandøren kan ikke holdes ansvarlig for omkostninger forbundet med forkert borede huller.

2



S Pluggar som följer med denna duschkörnan är lämpliga endast för tegel- eller betongväggar. I fall dina väggar är byggda av annat material, köp speciella pluggar i närmaste gör-det-själv butik. Alla hål borrade i en vägg i badrum måste tätas med silikon. Vi rekommenderar att applicera silikonerna innan pluggar sätts i hål och en gång till när de är installerade. Först sedan bör skruvar skrivas in.

DK De medfølgende rawplugs er kun beregnet til murstens- eller betonvægge. Hvis du har en anden type væg, skal du købe de rawplugs der passer til denne type væg i dit lokale bygge-marked. Alle skruehuller der bores i væggen i et badeværelse, skal forsegles med silikon. Vi anbefaler at komme silikon i skrue hullet før du sætter rawpluggen i hullet, og derefter silikon ind i rawpluggen inden du skruer skruen i rawpluggen.

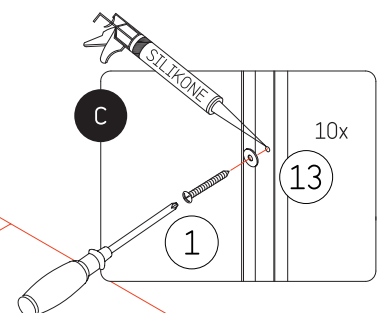
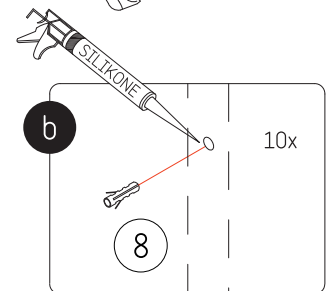
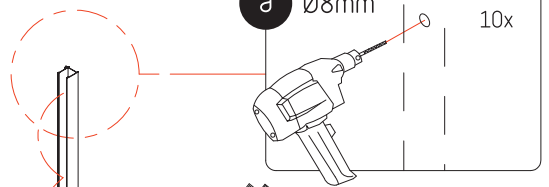
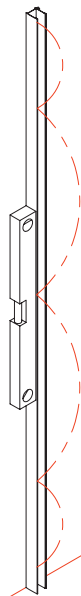

3

S OBS: Det är viktigt att du smörjer gångjärn med silikonfett (del 12) såsom bilden visar. Smörjer du inte gångjärn kommer det att gnissla efter kort tid

DK NB: Det er vigtigt at du påfører silikone fedt (del 12) på hængslerne som vist i denne manual. Hvis der ikke er påført fedt, vil hængslerne begynde at "skrige" kort tid efter.

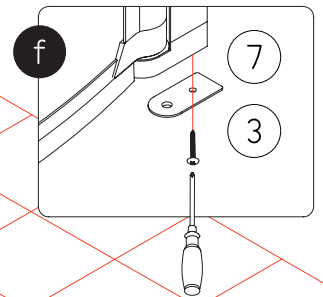
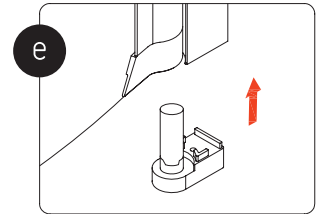
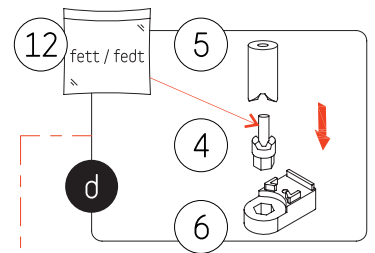
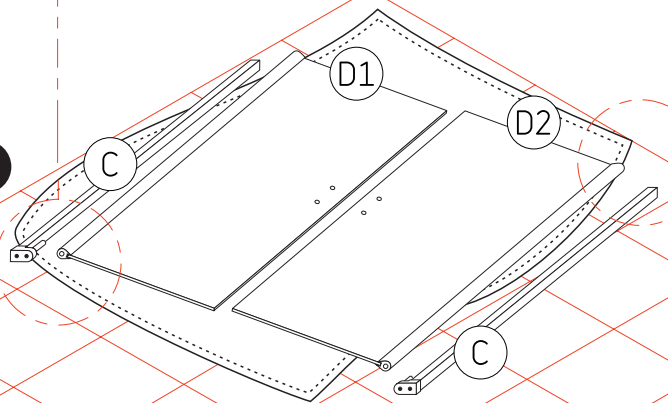
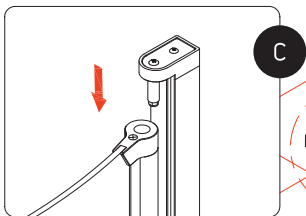
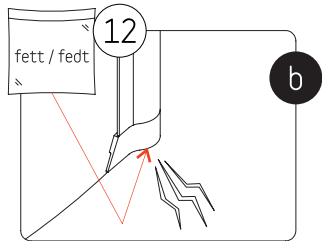
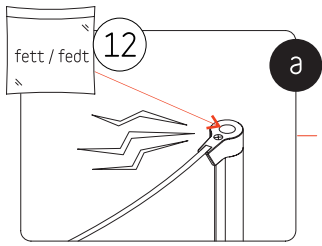

4

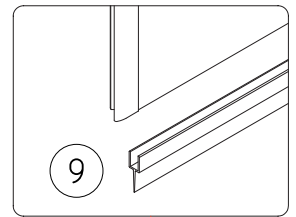
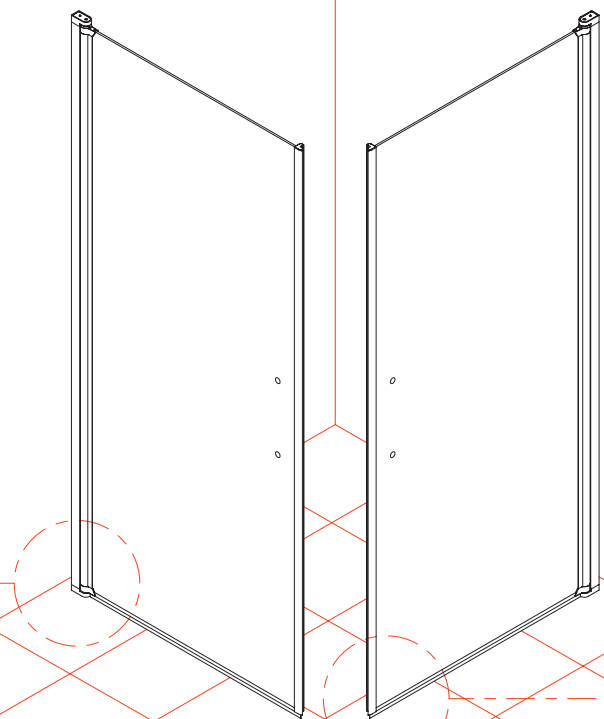
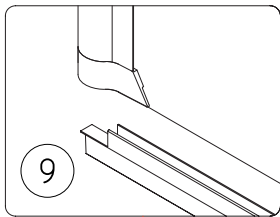

5

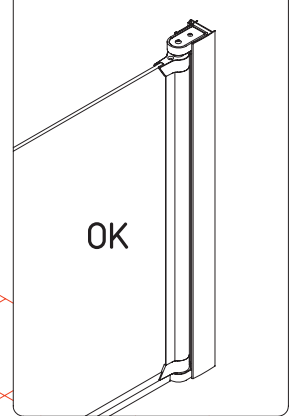
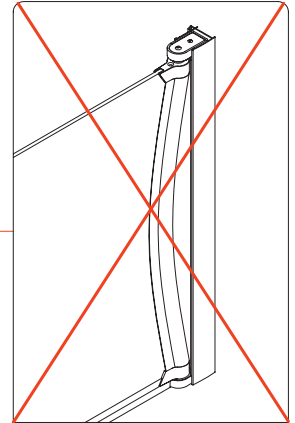
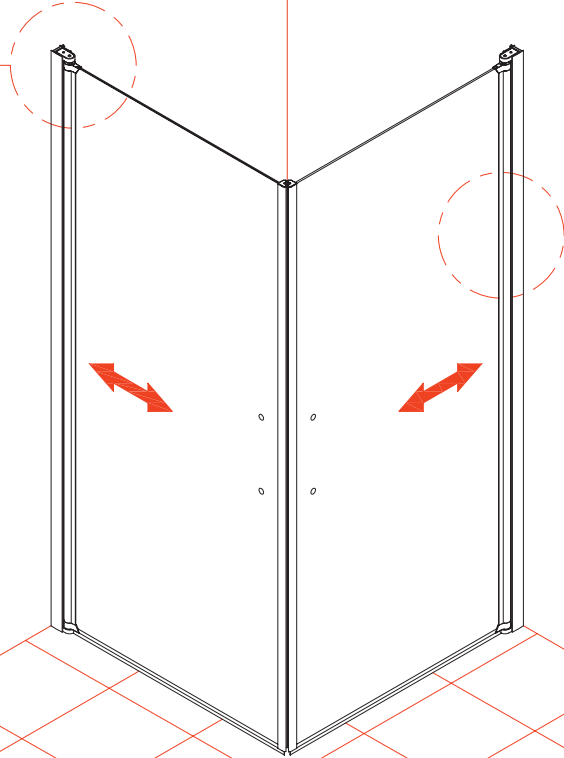
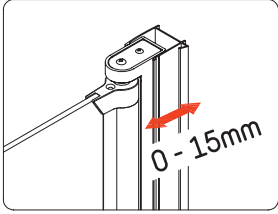
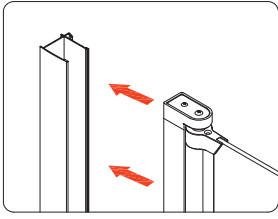

6

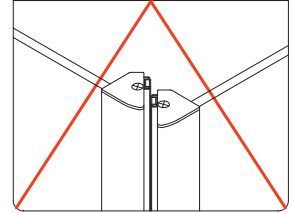
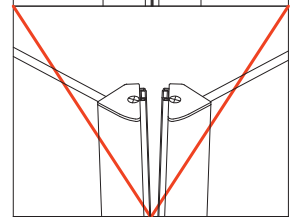
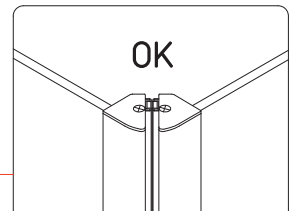
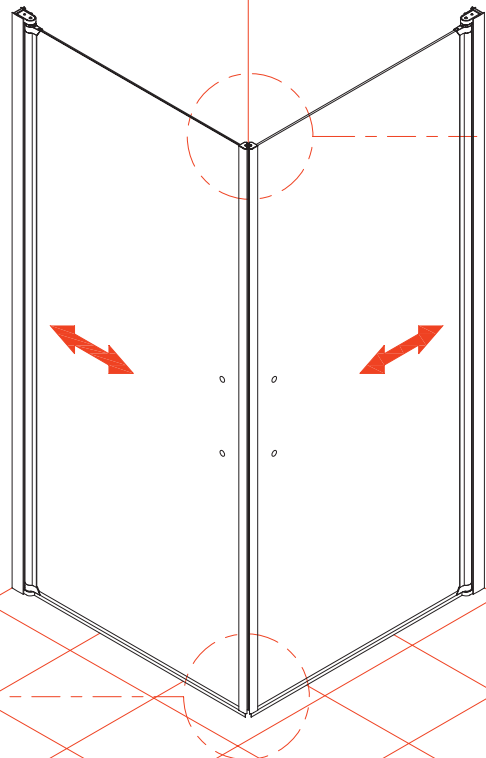
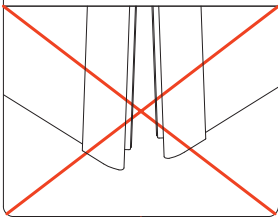
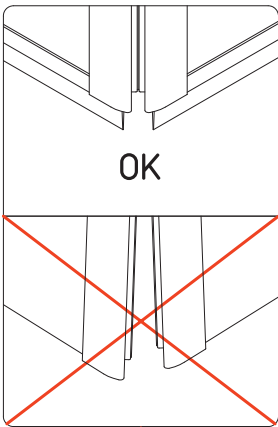

7

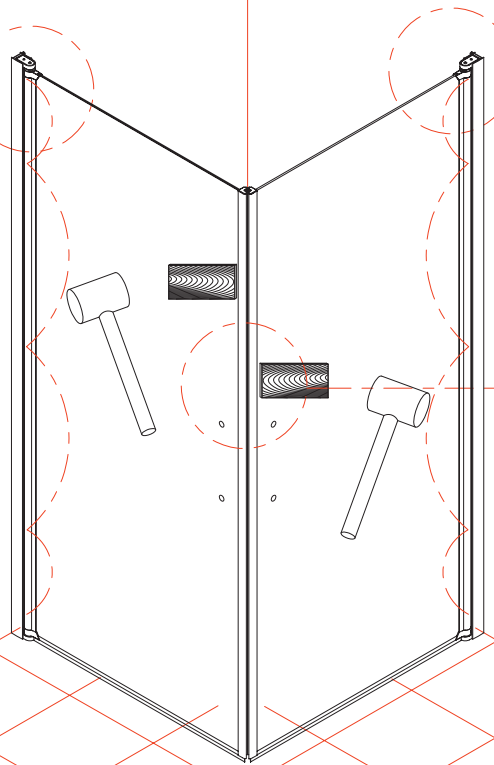
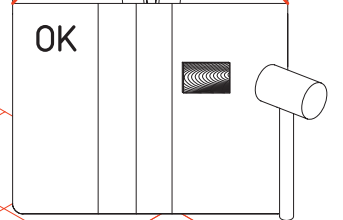
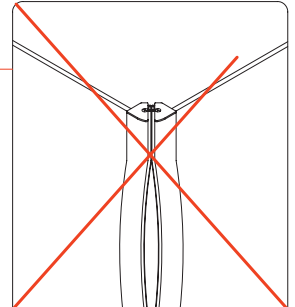
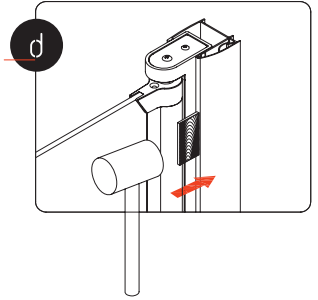
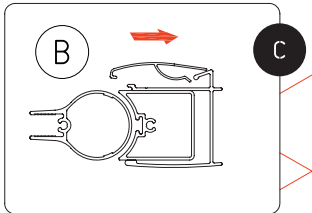
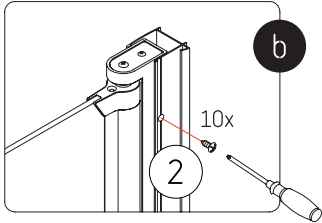
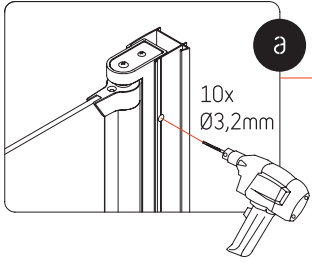

8

