

## DE Aufbauanleitung „HakenSet“

- Ⓞ GB Assembly manual for "Hook-Set"
- Ⓞ FR Notice de montage du "Jeu de crochets"
- Ⓞ NL Opbouwbeschrijving voor "Hakenzet"
- Ⓞ ES Instrucciones de montaje de "Set de ganchos"
- Ⓞ IT Istruzioni di montaggio "Set di ganci"
- Ⓞ DK Monteringsvejledning for "Krogsæt"

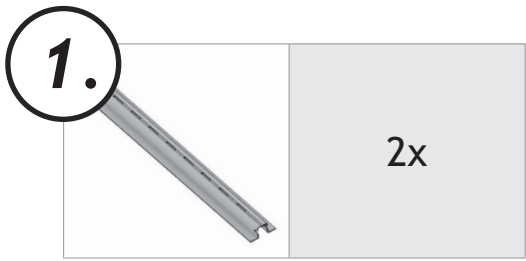



## nicht im Lieferumfang - Grundausrüstung

- Ⓒ not included in delivery - standard equipment
- Ⓕ non inclus - equipment de base
- Ⓖ niet inbegrepen - basis uitrusting
- Ⓔ no incluidos en el suministro - equipo básico
- Ⓗ non forniti in dotazione - dotazione di base
- Ⓓ følger ikke med - standardudstyr

1.

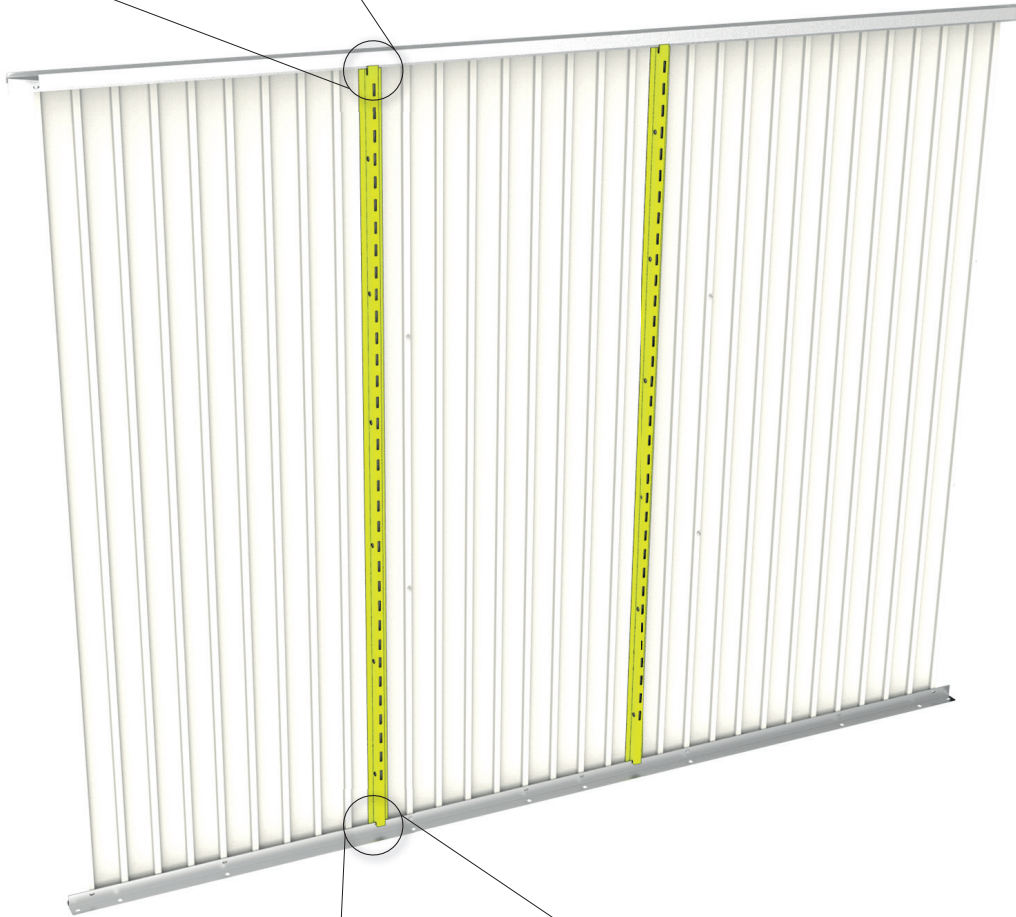
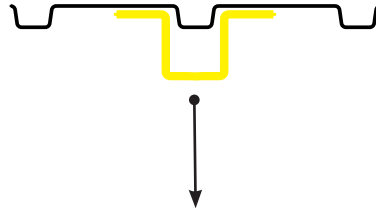
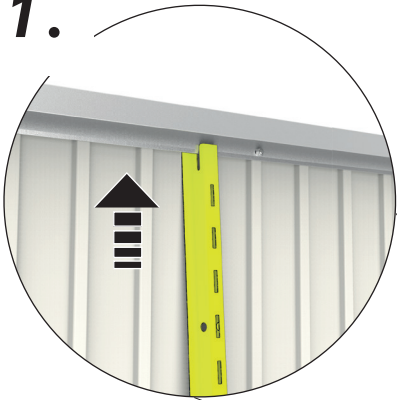

2.

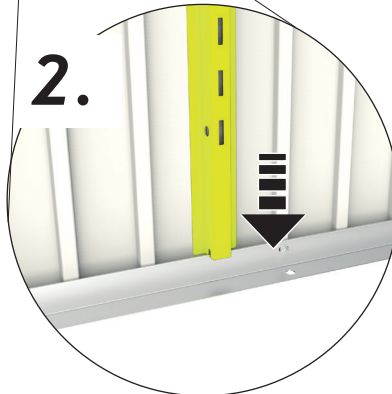

3.

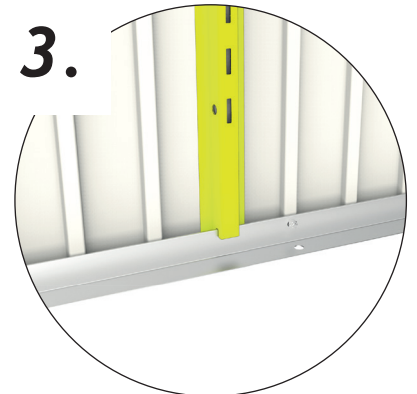

2.

	1x		2x		1x
	1x		1x	M5 x 18 	3x

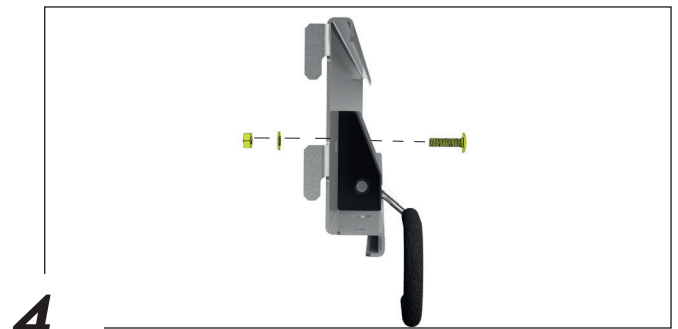
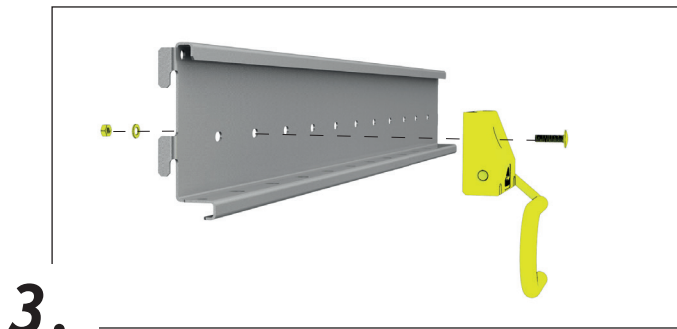
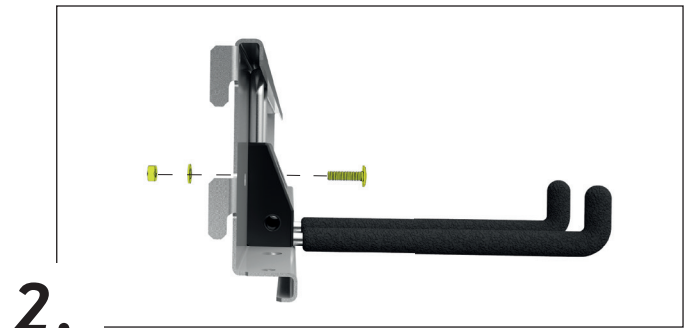
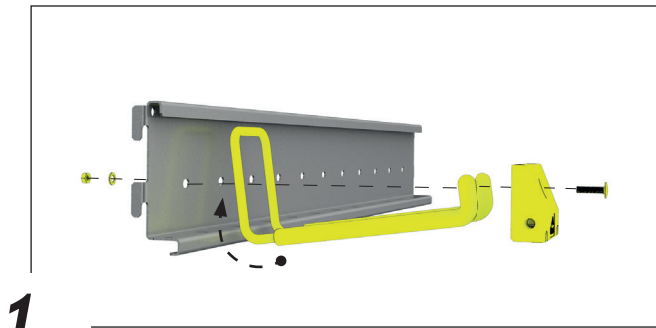

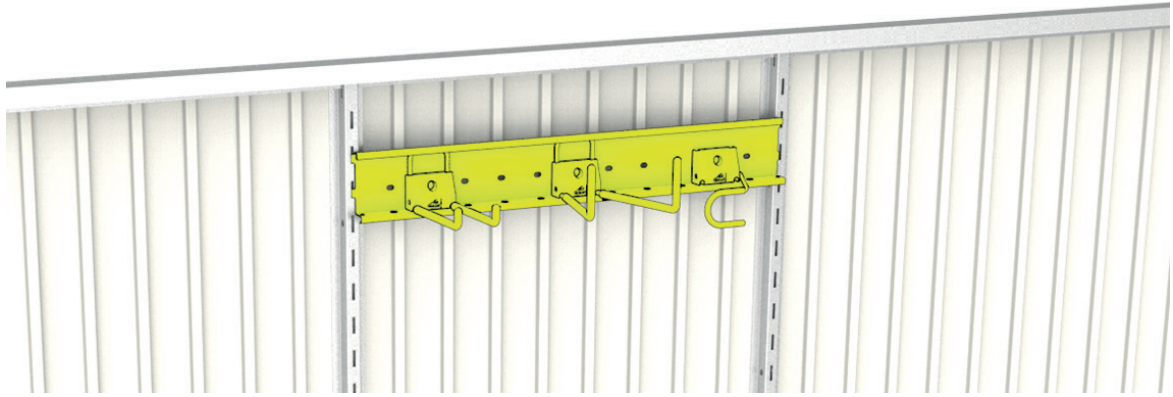

1.

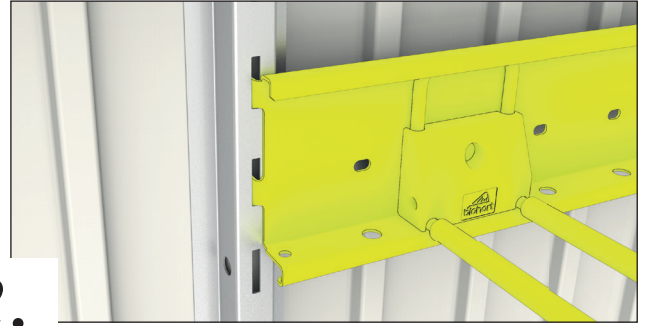

2.

3.



1.



2.

Y1047070  
Version 01 / 2018

Kontrollnummer:  
Control-number / Contrôle-Qualité / Controlnummer:

Bei Reklamationen bitte anführen:  
Kontrollnummer und Artikelnummer des reklamierten Teils.

GB: In case of complaint please indicate the control-number and the number of the item, which is subject of complaint.

F: Pour toutes réclamations: prière de joindre le numéro de contrôle et le numéro d'article de la pièce litigieuse.

NL: Bij reclamaties svp doorgeven: controlnummer en artikelnummer van het desbetreffende onderdeel.



**Biohort GmbH**  
Pürnstein 43, 4120 Neufelden, Österreich  
Tel.: +43-7282-7788-0, Fax-DW: 190  
E-Mail: office@biohort.at, www.biohort.com