

130

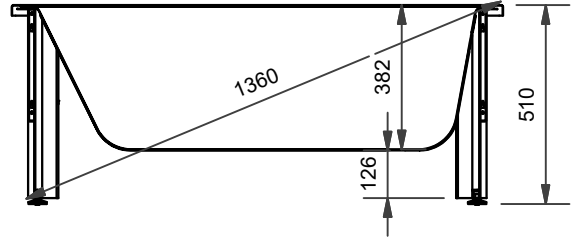

140

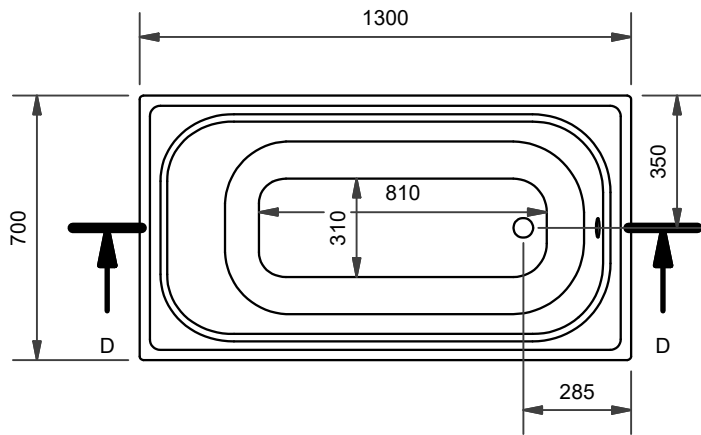
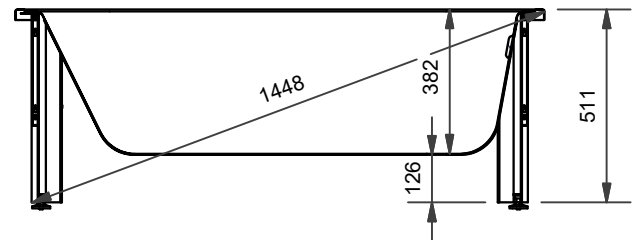
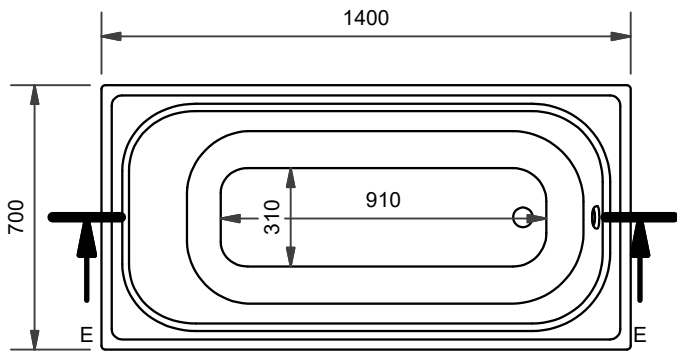

150

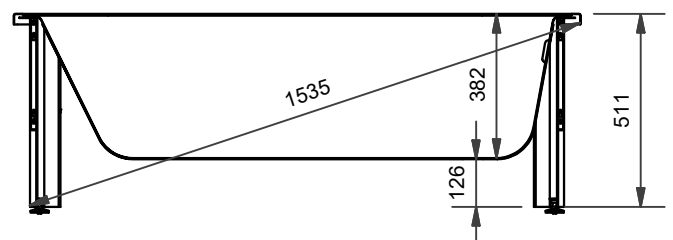
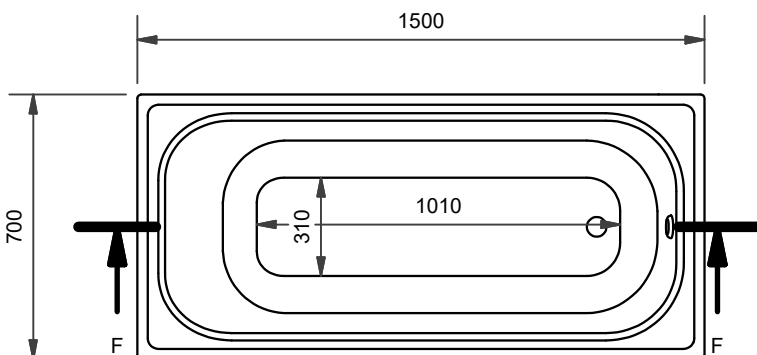

160 / 170

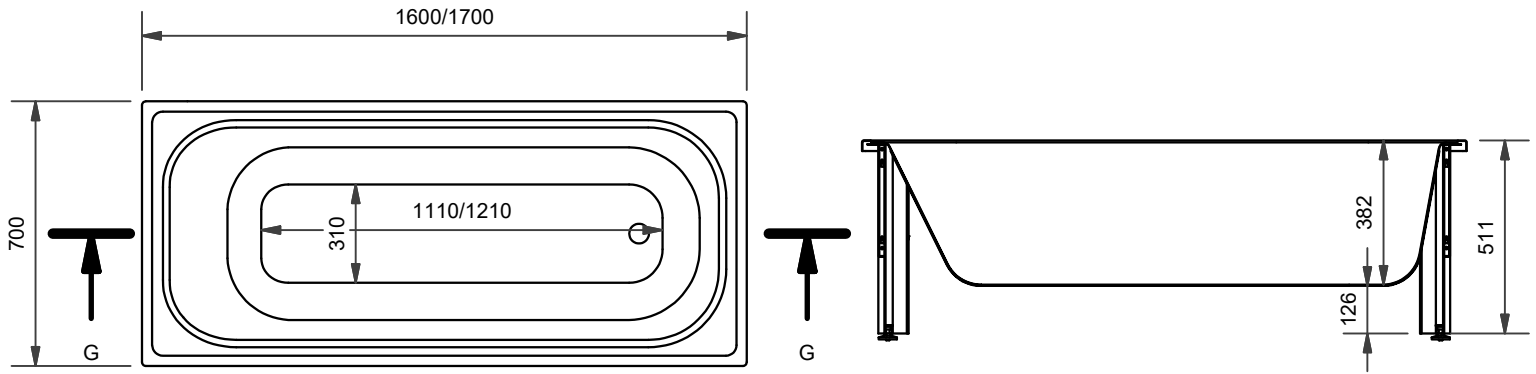

TOFTA

