

# BET skruv P

# Adjufix

The Original System Solution

## CONCRETE AND BRICK SCREW WITH PLUG

Concrete and brick screw with plug.  
For window and door frame mounting.

08-2021

**Safety factor: 4**



### Used in

### Load-bearing capacity

For concrete class C20/C25

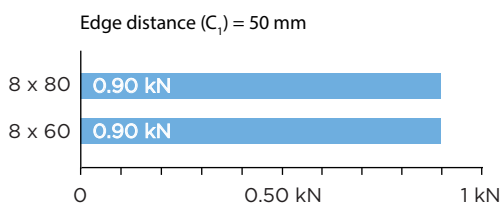
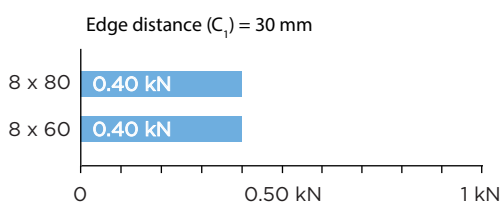
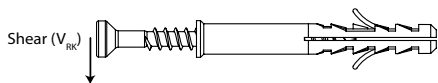
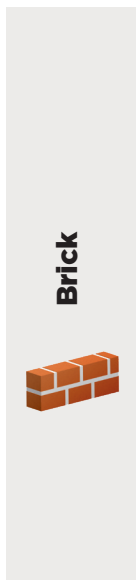
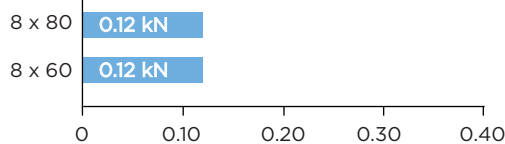
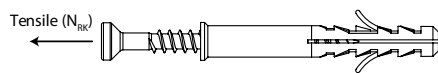

### Mounting guide

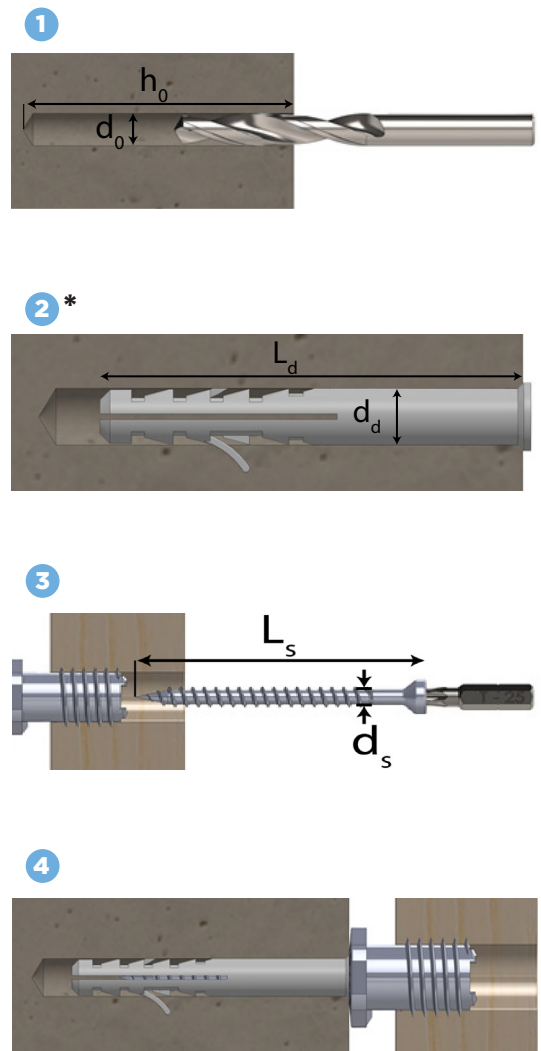

Sleeve dimension [mm]	Drilling depth [mm]	Drill diameter [mm]	Minimum edge distance [mm]	Tensile load capacity [kN]	Shear load capacity at $c_1=30\text{mm}$ [kN]	Shear load capacity at $c_1=50\text{mm}$ [kN]	Screw dimensions [mm]	ITW number
$d_d \times L_d$	$h_0$	$d_0$	$c_1$	$N_{RK}$	$V_{RK}$	$V_{RK}$	$d_s \times L_s$	
8 x 60	65	8	30	0.12	0.40	0.90	6 x 65	120109
8 x 80	85	8	30	0.12	0.40	0.90	6 x 88	120111

\* Make sure to thoroughly clean the drilled hole before mounting the sleeve