



# LED strips and matching profiles



Lighting without limits

Wide assortment

Variety of ideas and examples



## YourLED Stripes: Lighting without limits

Enchant entire rooms with LED light  
(lengths of up to max. 25 metres)



LED interior lighting for the kitchen – Coated YourLED Stripes can do it all (☐ = 9-10).

## Background lighting for your television



The desired effect at the press of a button – YourLED RGB Stripes (☐ = 11).

## Cosy bedroom lighting



Glare-free, "uplifting light" will make your furniture seem to levitate – YourLED ECO Stripes (☐ = 9).

# YourLED and YourLED ECO

Complete sets and expansions

**YourLED – Coated:** Can be cut to length and have a high light yield



**YourLED ECO – Uncoated:** Can be cut to length and reconnected

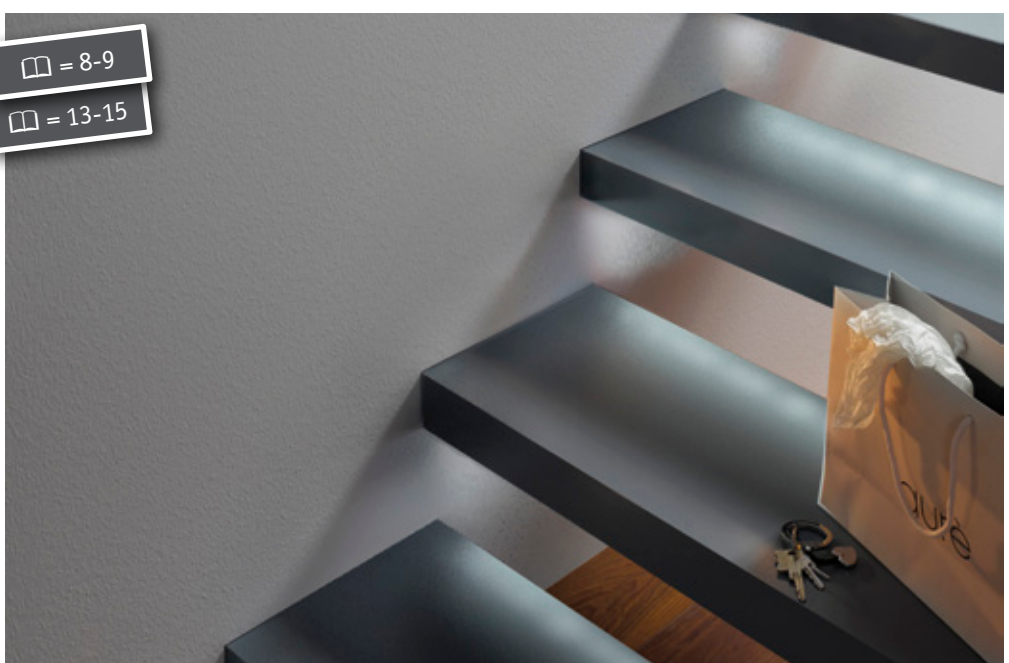

# Profiles

Specially designed for YourLED Stripes



**Duo Profil:** Use indirect lighting to create a special atmosphere in your living spaces with the Duo Profil made of high-quality aluminium (☎ 702.67).

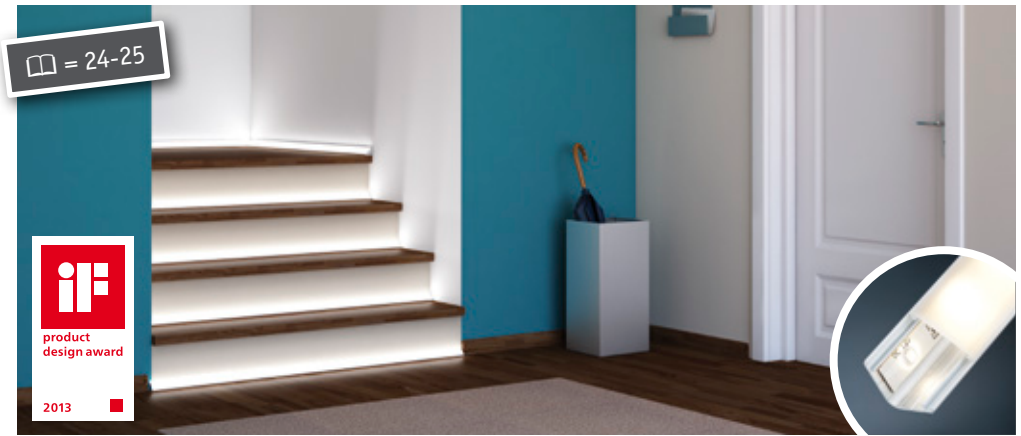

**Delta Profil:** Highlight your hallways with illuminated baseboards. Design experts honour the Delta Profil (☎ 702.61) for the iF product design award.



**Floor Profile:** Recessed profile for illumination with LED strips creates light accents on the floor

# Effect light and decorative light

Complete sets and expansions

**Digital LED Stripes:** Colours in motion

**Blacklight:** Florescent black light

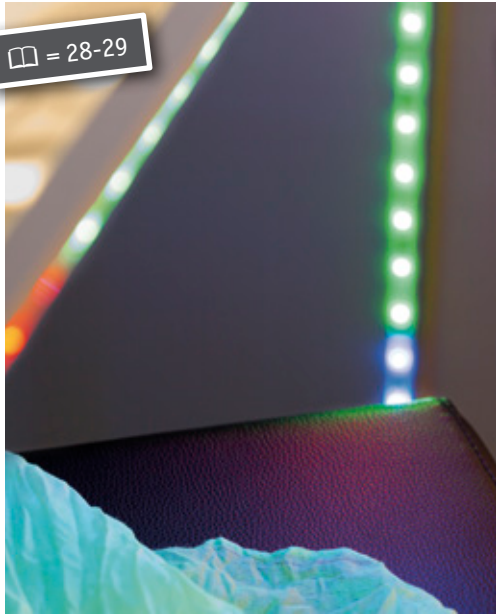

**YourLED Neon and YourLED Glitter:** Fascinating light effects: Afterglow and glitter effect

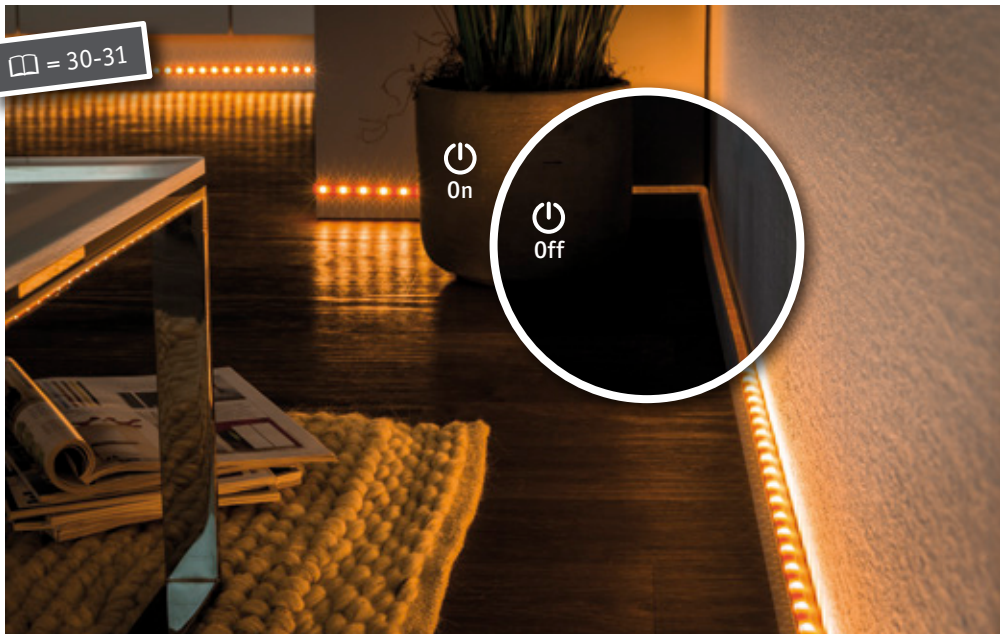

# Functional or comfortable

These luminous colours give you limitless possibilities

gold  
2000K

romantic

warm white  
3000K

cosy

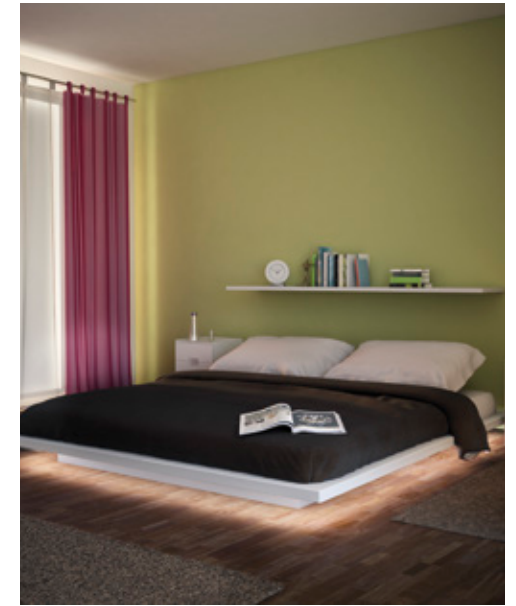
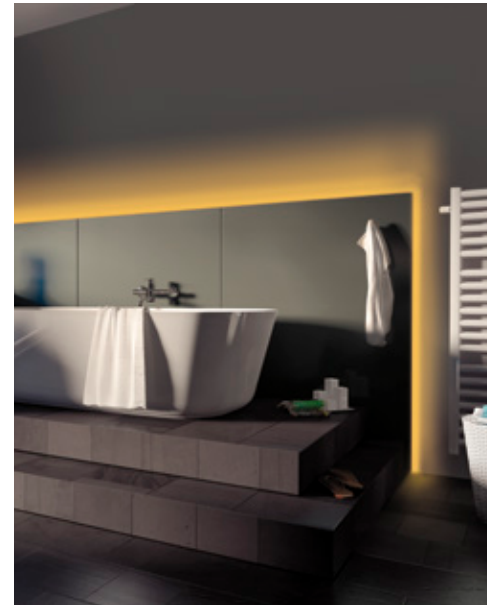

neutral white  
4000K

vibrant

daylight  
6000K

stimulating

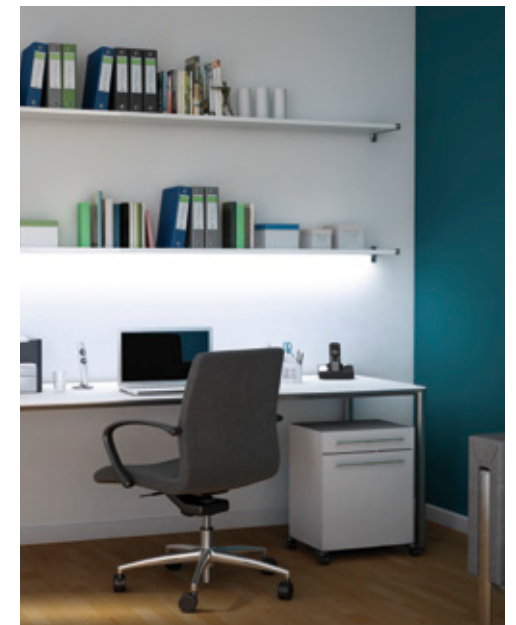

# YourLED and YourLED ECO Stripes



Quick and easy installation and layout without tools.

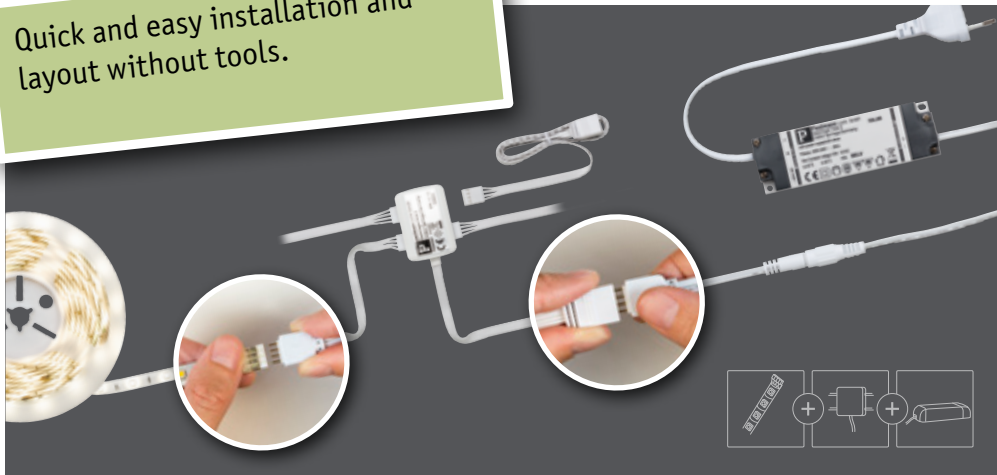

- ▶ No need for tools: The strips feature adhesive backing for quick and easy, tool-free installation.
- ▶ Flexibility in every direction and every space: A wide selection of accessories allows you to change direction and height.
- ▶ Get started in no time with ready-to-use sets and extend by up to 7.6 m (depending on the luminous colour).
- ▶ Mix and match to create a unique system for larger projects and connect to a power supply (transformer) up to a max. of 25 m.

## To fit your needs:

The strips come in two versions. YourLED Stripes are silicone-coated. YourLED ECO Stripes are uncoated.

### YourLED

Cut to length and high light yield



### YourLED ECO

Can be cut to length and reconnected



- |   |                                      |
|---|--------------------------------------|
| ▶ Can be cut to length every 7.5 cm           | ▶ Can be cut to length every 10 cm   |
| ▶ Reconnectable only if not shortened         | ▶ Connect after shortening           |
| ▶ High light yield (39 LEDs/m)                | ▶ Low energy consumption (30 LEDs/m) |
| ▶ Coating provides dust and splash protection | ▶ Particularly suitable for profiles |

## YourLED ECO – cut to length and reconnect

Eco Stripes are especially easy to shorten to the desired length. Shortened sections can be reconnected using the accessories on □□=15. That makes them ideal for branched projects or for installing in profiles.

Look how easy it is!

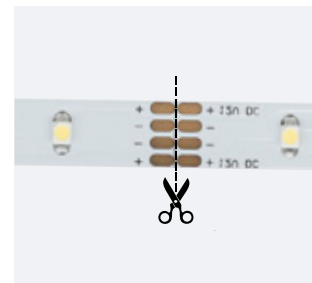

## Combine your own personal lighting system.

It only takes one strip and one power supply to make your light system shine. Expand your lighting system however you like with the wide selection of accessories. All components are compatible.

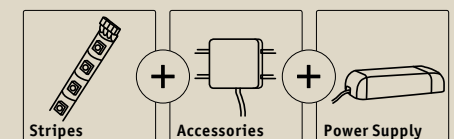

## YourLED – light for kitchens and baths

Splash-protected system, thanks to the coating and protected connections (IP44)



### YourLED: Coated strips

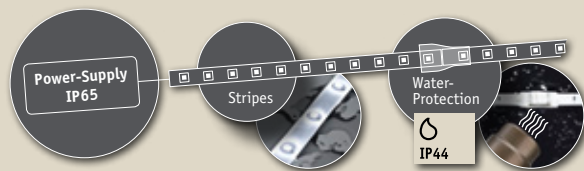

- ▶ Also suitable for rooms exposed to moisture: Thanks to coating and waterproof connections.
- ▶ Strips are safe for use in splash areas.
- ▶ Shrink tubing (702.47 Water Protection  $\square$ =20) provides splash protection for all connections on coated YourLED Stripes (not ECO Stripes).
- ▶ Higher light yield than YourLED ECO.
- ▶ Power Supply  $\square$ =16

## YourLED and YourLED ECO – colour change system (RGB)

Dramatically present curtains, ceiling niches or wall elements in your living spaces!

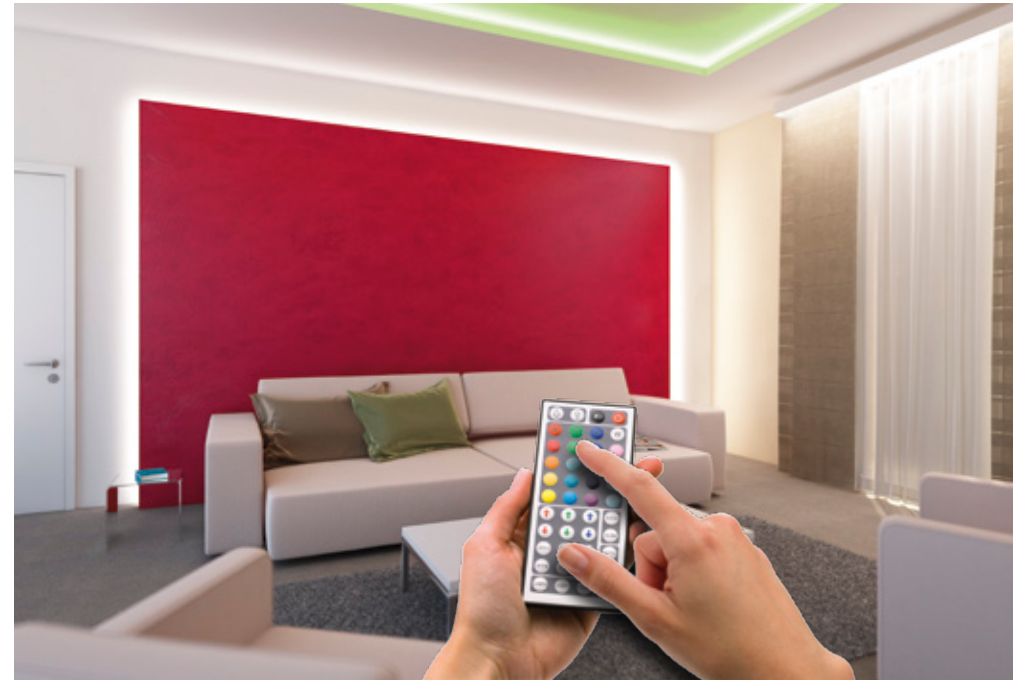

### This is what you'll need for your colour change system:

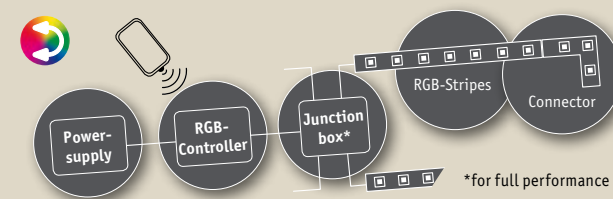

Conjure up coloured light in motion with the RGB control!  
Use the remote control to easily choose between:

- ▶ Selecting colours directly
- ▶ Mixing and saving your own colour
- ▶ Dimming
- ▶ "Fade" mode – subtle colour transitions
- ▶ Strobe light – with this party effect, all movements seem to be in slow motion



The RGB basic set contains all components!  
 $\square$ =12–13

## YourLED basic set

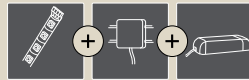

The first step into the world of strips

- ▶ High-quality coated YourLED Stripes
- ▶ The corresponding transformer and important accessories such as the connecting cable or RGB controller for colour change systems are included in the ready-to-use set.
- ▶ Available as 1.5 m or 3 m; both sizes in daylight white, warm white or the RGB colour change system.
- ▶ All sets are expandable! Use the wide selection available in the YourLED world for your personal project (□ = 14–15).

**warm white**  
3000K

**daylight**  
6000K



### Basic Set Warm white 1,5m

incl. 4,8 W  
300 lm, 3000 K  
230/12 V, 12 VA  
⌀3 mm ↗10,5 mm ↔1,5 m  
🛒 **703.17**  
expandable up to 4.8 m

### Basic Set Daylight 1,5m

incl. 4,8 W  
420 lm, 6000 K  
230/12 V, 12 VA  
⌀3 mm ↗10,5 mm ↔1,5 m  
🛒 **703.18**  
expandable up to 4.8 m

### Basic Set RGB 1,5m

incl. 14,4 W  
420 lm  
230/12 V, 22 VA  
⌀3 mm ↗10,5 mm ↔1,5 m  
🛒 **703.19**  
expandable up to 2.5 m



### Basic Set Warm white 3m

incl. 9,7 W  
600 lm, 3000 K  
230/12 V, 22 VA  
⌀3 mm ↗10,5 mm ↔3 m  
🛒 **703.20**  
expandable up to 7.6 m

### Basic Set Daylight 3m

incl. 9,7 W  
840 lm, 6000 K  
230/12 V, 12 VA  
⌀3 mm ↗10,5 mm ↔3 m  
🛒 **703.21**  
expandable up to 7.6 m

### Basic Set RGB 3m

incl. 28,8 W  
840 lm  
230/12 V, 48 VA  
⌀3 mm ↗10,5 mm ↔3 m  
🛒 **703.22**  
expandable up to 5 m

## YourLED ECO basic set

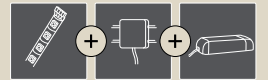

The first step into the world of strips

- ▶ Flexible ECO Stripes perfectly suitable for profiles □ = 21–27
- ▶ The corresponding transformer and important accessories such as the connecting cable or RGB controller for colour change systems are included in the ready-to-use set.
- ▶ Available as 3 m; in neutral white, warm white and the RGB colour change system.
- ▶ All sets are expandable! Use the wide selection available in the YourLED world for your personal project (□ = 14–15).

**warm white**  
3000K

**neutral white**  
4000K



### Basic Set Warm white 3m

incl. 7,2 W  
450 lm, 3000 K  
230/12 V, 12 VA  
⌀2,5 mm ↗10,5 mm ↔3 m  
🛒 **704.28**  
expandable up to 4.8 m

### Basic Set Neutral white 3m

incl. 7,2 W  
450 lm, 4000 K  
230/12 V, 12 VA  
⌀2,5 mm ↗10,5 mm ↔3 m  
🛒 **704.29**  
expandable up to 4.8 m

### Basic Set RGB 3m

incl. 21,6 W  
630 lm  
230/12 V, 24 VA  
⌀2,5 mm ↗10,5 mm ↔3 m  
🛒 **704.30**  
expandable up to 5 m



[www.paulmann.com/yourledvideo/all](http://www.paulmann.com/yourledvideo/all)

# Create your own personal lighting system

## YourLED Stripes and YourLED ECO Stripes

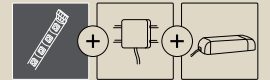

Expand your basic set (☐=12-13) with steps ①-③ or create your very own individual

① The first step is to choose the number of strips you'll need: Choose **coated strips** with higher light yield or **reconnectable ECO Stripes**. (Info ☐ = 8-9)

② Choose your **luminous colour**: Info ☐=7, 11

### YourLED

- ▶ High light yield
- ▶ Can be cut to length every 7.5 cm

warm white <b>3000 K</b>	195 lumen/metre
daylight <b>6000 K</b>	280 lumen/metre

### YourLED RGB

- ▶ High light yield
- ▶ Can be cut to length every 7.5 cm

273 lumen/metre

### YourLED Gold and Blue

- ▶ Can be cut to length every 7.5 cm

gold <b>2000 K</b>	160 lumen/metre
blue	80 lumen/metre

### YourLED ECO

- ▶ Can be cut to length every 10 cm and reconnected

warm white <b>3000 K</b>	150 lumen/metre
neutral white <b>4000 K</b>	150 lumen/metre

### YourLED RGB ECO

- ▶ Can be cut to length every 10 cm and reconnected

210 lumen/metre

system with steps ①-⑥.

③ Choose the **length** ⇄ of the desired strips (see example below)

Install around 90° corners with the Edge Connector

Bridge short distances with the Distance Pack

⇄ 97,5 cm 3,12 W 🛒 702.08	3x ⇄ 97,5 cm 3x 3,12 W 🛒 702.12	⇄ 97,5 cm 3,12 W 🛒 702.09	3x ⇄ 97,5 cm 3x 3,12 W 🛒 702.13	⇄ 97,5 cm 3,12 W 🛒 702.10	3x ⇄ 97,5 cm 3x 9,36 W 🛒 702.14	⇄ 97,5 cm 3,12 W 🛒 702.11	⇄ 97,5 cm 3,12 W 🛒 702.11
⇄ 4,2 cm 3x 0,24 W 🛒 702.05	⇄ 4,2 cm 3x 0,24 W 🛒 702.06	⇄ 4,2 cm 3x 0,72 W 🛒 702.07	⇄ 4,2 cm 3x 0,72 W 🛒 702.07	⇄ 4,2 cm 3x 0,72 W 🛒 702.07	⇄ 4,2 cm 3x 0,72 W 🛒 702.07	⇄ 4,2 cm 3x 0,72 W 🛒 702.07	⇄ 4,2 cm 3x 0,72 W 🛒 702.07
2x ⇄ 2,5 cm, 2x ⇄ 7,5 cm 2x 0,08 W, 2x 0,24 W 🛒 703.36	2x ⇄ 2,5 cm, 2x ⇄ 7,5 cm 2x 0,08 W, 2x 0,24 W 🛒 703.37	2x ⇄ 2,5 cm, 2x ⇄ 7,5 cm 2x 0,24 W, 2x 0,72 W 🛒 703.38	2x ⇄ 2,5 cm, 2x ⇄ 7,5 cm 2x 0,24 W, 2x 0,72 W 🛒 703.38	2x ⇄ 2,5 cm, 2x ⇄ 7,5 cm 2x 0,24 W, 2x 0,72 W 🛒 703.38	2x ⇄ 2,5 cm, 2x ⇄ 7,5 cm 2x 0,24 W, 2x 0,72 W 🛒 703.38	2x ⇄ 2,5 cm, 2x ⇄ 7,5 cm 2x 0,24 W, 2x 0,72 W 🛒 703.38	2x ⇄ 2,5 cm, 2x ⇄ 7,5 cm 2x 0,24 W, 2x 0,72 W 🛒 703.38

⇄ 97,5 cm 9,36 W 🛒 702.10	3x ⇄ 97,5 cm 3x 9,36 W 🛒 702.14	⇄ 97,5 cm 9,36 W 🛒 702.10	3x ⇄ 97,5 cm 3x 9,36 W 🛒 702.14	⇄ 97,5 cm 9,36 W 🛒 702.10	3x ⇄ 97,5 cm 3x 9,36 W 🛒 702.14	⇄ 97,5 cm 9,36 W 🛒 702.10	3x ⇄ 97,5 cm 3x 9,36 W 🛒 702.14
⇄ 4,2 cm 3x 0,72 W 🛒 702.07	⇄ 4,2 cm 3x 0,72 W 🛒 702.07	⇄ 4,2 cm 3x 0,72 W 🛒 702.07	⇄ 4,2 cm 3x 0,72 W 🛒 702.07	⇄ 4,2 cm 3x 0,72 W 🛒 702.07	⇄ 4,2 cm 3x 0,72 W 🛒 702.07	⇄ 4,2 cm 3x 0,72 W 🛒 702.07	⇄ 4,2 cm 3x 0,72 W 🛒 702.07
2x ⇄ 2,5 cm, 2x ⇄ 7,5 cm 2x 0,24 W, 2x 0,72 W 🛒 703.38	2x ⇄ 2,5 cm, 2x ⇄ 7,5 cm 2x 0,24 W, 2x 0,72 W 🛒 703.38	2x ⇄ 2,5 cm, 2x ⇄ 7,5 cm 2x 0,24 W, 2x 0,72 W 🛒 703.38	2x ⇄ 2,5 cm, 2x ⇄ 7,5 cm 2x 0,24 W, 2x 0,72 W 🛒 703.38	2x ⇄ 2,5 cm, 2x ⇄ 7,5 cm 2x 0,24 W, 2x 0,72 W 🛒 703.38	2x ⇄ 2,5 cm, 2x ⇄ 7,5 cm 2x 0,24 W, 2x 0,72 W 🛒 703.38	2x ⇄ 2,5 cm, 2x ⇄ 7,5 cm 2x 0,24 W, 2x 0,72 W 🛒 703.38	2x ⇄ 2,5 cm, 2x ⇄ 7,5 cm 2x 0,24 W, 2x 0,72 W 🛒 703.38

⇄ 97,5 cm 3,12 W 🛒 704.62	⇄ 97,5 cm 3,12 W 🛒 702.11	
⇄ 50 cm 1,2 W 🛒 701.96	⇄ 300 cm 7,2 W 🛒 702.54	⇄ 500 cm 12 W 🛒 702.55
⇄ 50 cm 1,2 W 🛒 701.97	⇄ 300 cm 7,2 W 🛒 702.56	⇄ 500 cm 12 W 🛒 702.57
⇄ 50 cm 3,6 W 🛒 701.98	⇄ 300 cm 21,6 W 🛒 702.52	⇄ 500 cm 36 W 🛒 702.53

### Example

Long side	1x702.12 (3x97,5 cm)
Short side	1x702.08 (1x97,5 cm)
Corner	1x702.05 (Edge Connector)

If you plan on installing 3 m and 1 m coated strips in the kitchen, you will need 1x 🛒 702.12, 1x 🛒 702.08 and for the corner 1x 🛒 702.05 for the corner.

④ Select the corresponding **transformer** ☐ = 16

⑤ Wide selection of **connector accessories** ☐ = 17

⑥ For the RGB colour change system, you will need the **RGB controller** ☐ = 19



## Power supply transformers

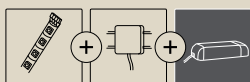

④ **Select the corresponding transformer:** Sum of the wattage of the selected strips is a maximum of:

	15W Power Supply	48W Power Supply	60W Power Supply
	The total length of the selected strips may be a maximum of ... :		
YourLED	4 m	15 m (9 m + 6 m)*	19 m (9 m + 9 m + 1 m)*
YourLED ECO & DECO	6 m	20 m (12 m + 8 m)*	25 m (12 m + 12 m + 1 m)*
YourLED RGB	1 m	5 m (4 m + 1 m)*	6 m (4 m + 2 m)*
YourLED ECO RGB	2 m	6,5 m (6 m + 0,5 m)*	8 m (6 m + 2 m)*

\* For optimum system performance, please use the Junction-Box = 17.

### How to choose the corresponding transformer (power supply)

Refer to the table to find the ideal power supply for the selected length and type of strip.

*Example:*

A length of 14 m of coated YourLED Stripes can be achieved with the 48W power supply (max. 15 m).

	15W Power Supply	48W Power Supply	60W Power Supply
	The total length of the selected strips may be a maximum of ... :		
4 m	15 m (9 m + 6 m)*	19 m (9 m + 9 m + 1 m)*	

Please note that the value in parentheses (9 m) listed first under the total length (15 m) specifies the maximum length that can be *directly connected to the transformer*. For a length of 14 m, a junction box is required for distributing the power:

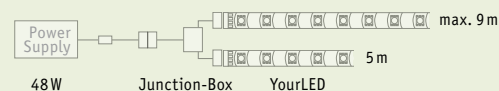

#### Power Supply 15 W

max. 15 W  
230/12V, 15 VA  
⌀18 ⇄125 ↗40 mm  
🛒 701.99



#### Power Supply 48 W

max. 48 W  
230/12V, 48 VA  
⌀40 ⇄135 ↗55 mm  
🛒 702.00



#### Power Supply 60 W IP65

max. 60 W   
230/12V, 60 VA  
⌀40 ⇄225 ↗60 mm  
🛒 702.01

## Strip accessories

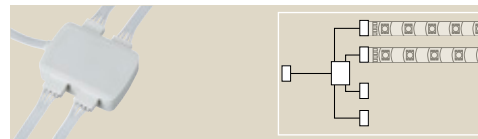
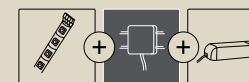

- ▶ For arranging the strips in different directions.
- ▶ For separating different luminous colours (e.g. RGB + warm white).



#### Junction-Box

4x 50 cm  
⌀12 ⇄30 ↗45 mm  
🛒 702.03



- ▶ For connecting YourLED or YourLED ECO Stripes in the **desired direction**.



#### X-Connector

⌀7 ⇄33 ↗33 mm  
🛒 702.82



- ▶ For connecting **two shortened** YourLED ECO Stripes.



#### ECO Clip-to-Clip Connector

2x  
⌀4,5 ⇄17 ↗18 mm  
🛒 704.89

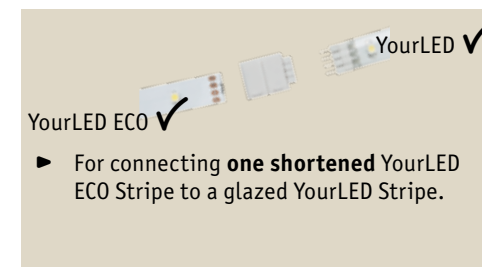

- ▶ For connecting **one shortened** YourLED ECO Stripe to a glazed YourLED Stripe.



#### ECO Clip-to-YourLED Connector

2x  
⌀4,5 ⇄23 ↗18 mm  
🛒 704.90

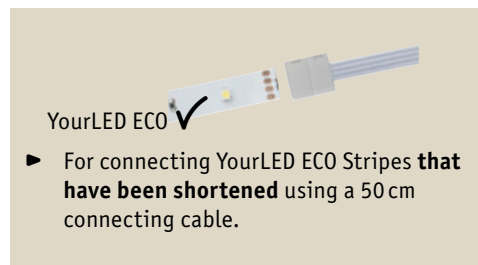

- ▶ For connecting YourLED ECO Stripes **that have been shortened** using a 50 cm connecting cable.



#### ECO Clip-Connector Set

2x  
⌀5 mm ⇄13 mm ⇄0,5 m  
🛒 704.88



- ▶ For connecting YourLED Stripes in **90° corners**.



#### Edge-Connector Pack

in each colour, 2x  
⌀12 ⇄17 ↗13 mm  
🛒 703.34

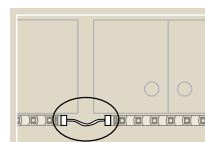

- ▶ For connecting unshortened YourLED or YourLED ECO Stripes with a connecting cable of corresponding length.
- ▶ Perfectly suited for positioning the transformer out of sight.



#### Flex-Connector 10cm

🛒 702.15  
⌀5 mm ⇄13 mm ⇄0,11 m

#### Flex-Connector 1m

🛒 702.04  
⇄13 mm ↗5 mm ⇄1 m

#### Flex-Connector 5m

🛒 702.51  
⇄13 mm ↗5 mm ⇄5 m

# Light control

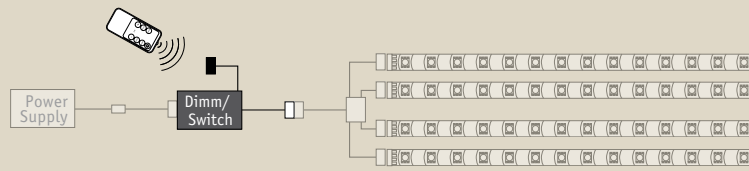

- ▶ To control or dim monochrome YourLED, YourLED ECO or DECO Stripes.
- ▶ The controller with remote control makes operation easy and provides a pleasant, dimmable mood light.



**Dimm/Switch Controller**  
 max. 60 W  
 DC 12 V  
 ⚡22 ↔63 ⚡35 mm  
 🛒 704.61

# RGB lighting control

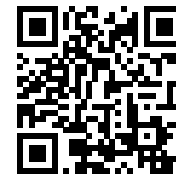
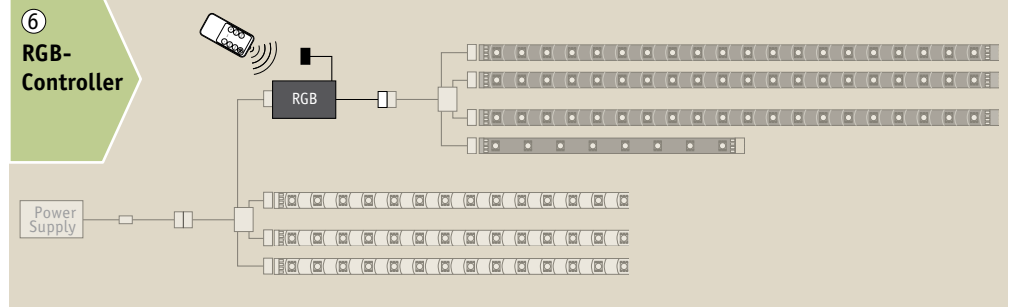

[www.paulmann.com/yourledcolours](http://www.paulmann.com/yourledcolours)



**RGB-Controller 12V DC**  
 max. 60 W  
 DC 12 V  
 ⚡22 ↔60 ⚡35 mm  
 🛒 702.02

For amplifying the control signal from the YourLED dim/switch controller 🛒 704.61

- ▶ This makes it possible to dim or control larger monochrome YourLED, YourLED ECO or DECO Stripe systems synchronously using a remote control.
- ▶ An additional power supply is connected through each amplifier to increase system performance.



**Amplifier**  
 max. 60 W  
 DC 12 V  
 ⚡24 ↔105 ⚡65 mm  
 🛒 704.52

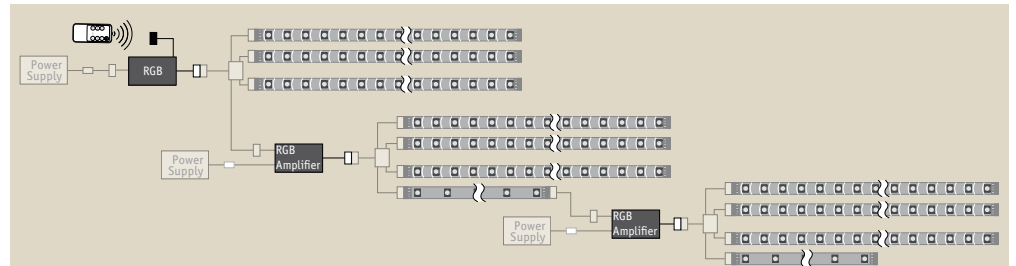

For amplifying control signals from the YourLED RGB Controller 🛒 702.02.

- ▶ A remote control allows you to control larger YourLED or YourLED ECO RGB Stripe systems **synchronously**.
- ▶ Connect an additional power supply through each amplifier to increase system performance.

## Sensor Switching on/off



Proximity switch for switching on and off the LED strips and other products.

- ▶ Install the proximity switch up to 2 m from the transformer to conveniently switch the light on and off without physical contact.
- ▶ For use with all switching operations up to 60 W.



**PIR-Sensor**  
 max. 60 W  
 230 V  
 ⚡19 ↔85 ⚡36 mm, ø17,5  
 🛒 704.51

## Synchronised control of extensive RGB installations



**RGB Amplifier**  
 max. 60 W  
 DC 12 V  
 ⚡24 ↔105 ⚡65 mm  
 🛒 703.35

## Sideview Stripes

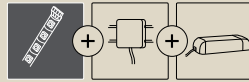

### Tip

The YourLED ECO Sideview Stripes are the ideal solution for lighting objects such as picture frames or mirrors from behind. The LED strips emit light to the side, creating a dramatic halo of light around the object.

- ▶ 30 LED per uncoated ECO Stripe
- ▶ Luminous colours 3000 K and 4000 K



### ECO Sideview Warm white 50 cm

incl. 2,4 W  
128 lm, 3000 K  
DC 12 V  
∅2,5 ⇄500 ⇄10,5 mm  
🛒 703.32

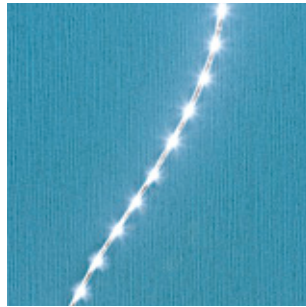

### ECO Sideview Neutral white 50 cm

incl. 2,4 W  
139 lm, 4000 K  
DC 12 V  
∅2,5 ⇄500 ⇄10,5 mm  
🛒 703.33

## IP protection against moisture

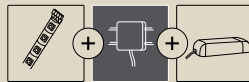

### Tip

You can retrofit your coated YourLED Stripes with IP protection.

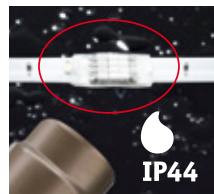

IP44

Apply heat to the shrink tubing over the links.

☐ = 12 YourLED Basic Set,  
☐ = 14-15 YourLED Stripes, YourLED RGB Stripes, YourLED Gold, YourLED Blue

+ Water-Protection  
🛒 702.47

= IP44

### Water Protection

∅14 ⇄150 mm  
🛒 702.47



## Duo Profil

The assembly solution for decorative room lighting



Indirect lighting with LEDs gives your space a whole new feel and creates a warm, pleasant atmosphere.

### Create highlights in your living area to enhance the atmosphere in your home.

- ▶ An Eloxal coating both protects the aluminium profile and lends it a satin sheen.
- ▶ Optional diffuser for uniform lighting effects.
- ▶ The profiles and diffuser can be individually cut to length and are compatible with all of the LED strips in the YourLED assortment.

A range of lighting effects are possible, depending on the placement.

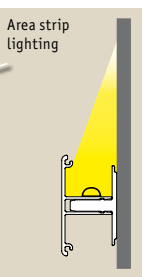
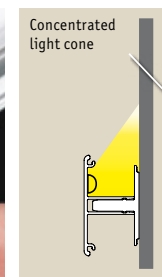

# Duo Profil

# Dramatic structuring of space on walls and ceilings

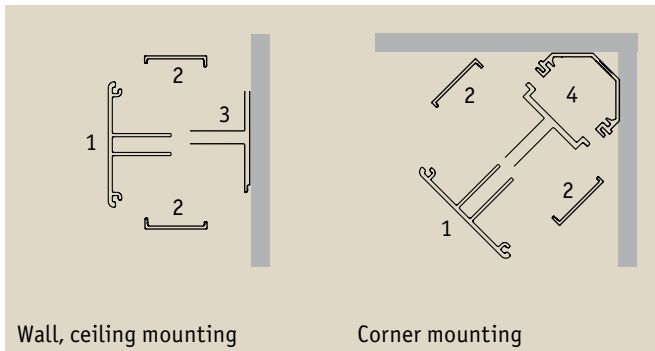
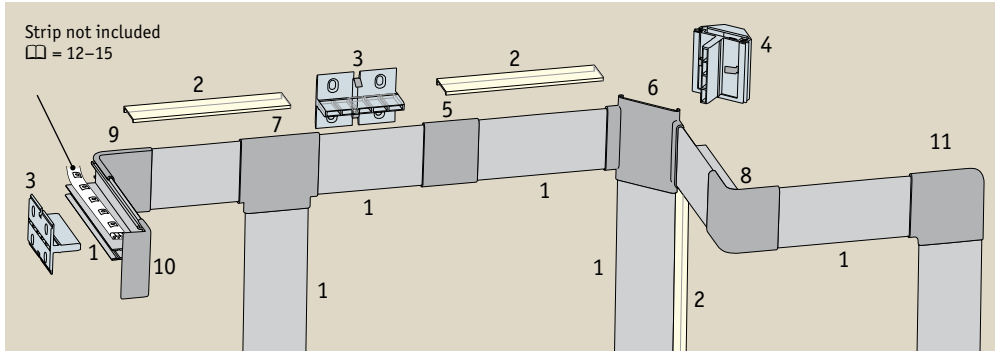

**Flat strip light without diffuser**



**Flat strip light with diffuser**

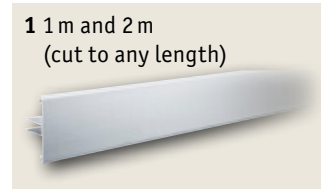

**1 1 m and 2 m (cut to any length)**

**Duo Profil 1m**  
1x  
42 mm 20 mm 1 m  
702.68

**Duo Profil 2m**  
1x  
42 mm 20 mm 2 m  
702.67



**2 2 m for uniform lighting effects**

**Duo Profil Diffusor**  
1x  
4 mm 20 mm 2 m  
702.69

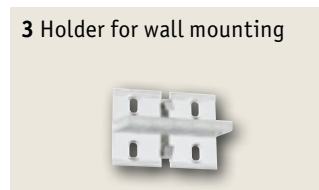

**3 Holder for wall mounting**

**Duo Profil Fixture**  
4 pc. set  
36 mm 50 mm 21 mm  
702.75

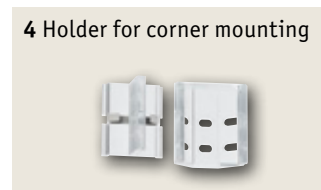

**4 Holder for corner mounting**

**Duo Profil Clix**  
4 pc. set  
40 mm 36 mm 37 mm  
702.21



**5 Cover plate**

**Duo Profil Cover**  
4 pc. set  
42 mm 35 mm 5 mm  
702.70

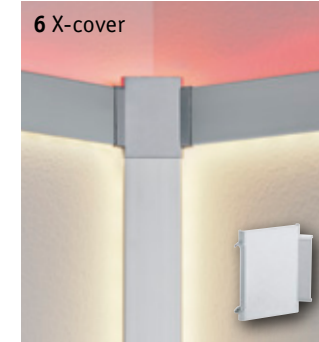

**6 X-cover**

**Duo Profil X-Cover**  
2 pc. set  
55 mm 55 mm 10 mm  
703.30



**7 T-cover**

**Duo Profil T-Cover**  
2 pc. set  
49 mm 50 mm 5 mm  
702.71



**8 Outer corner**

**Duo Profil Outside Corner**  
2 pc. set  
42 mm 35 mm 35 mm  
702.73

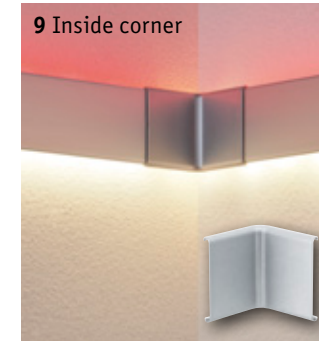

**9 Inside corner**

**Duo Profil Inside Corner**  
2 pc. set  
42 mm 39 mm 39 mm  
702.72

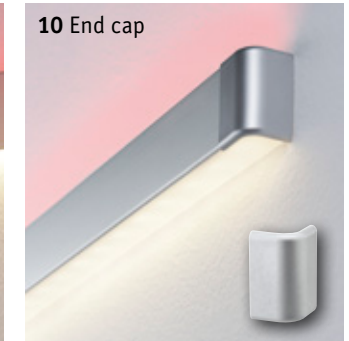

**10 End cap**

**Duo Profil End Cap**  
2 pc. set  
42 mm 22 mm 24 mm  
702.74

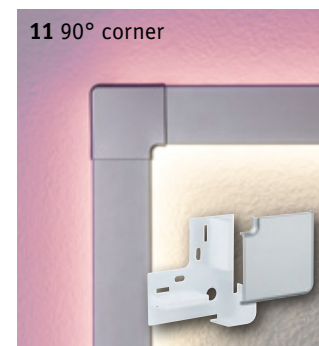

**11 90° corner**

**Duo Profil 90° Corner**  
2 pc. set  
20 mm 60 mm 60 mm  
704.53



[www.paulmann.com/yourledvideo/all](http://www.paulmann.com/yourledvideo/all)

# Delta Profil



## iF Product Design Award 2013

Design experts from across the world honour the Paulmann Delta Profil with the iF product design award. The international jury awards this globally-recognised seal of quality to products of excellent design.



## Illuminated baseboards as highlights

- ▶ The triangular profiles can be used with YourLED Stripes for a range of applications, including the illumination of baseboards, closing edges and undercabinets.
- ▶ The high-quality aluminium profiles have been coated with Eloxal for protection against dents or scratches.
- ▶ Delta Profiles can be individually cut to length and are compatible with all of the LED strips in the YourLED assortment.

A range of lighting effects are possible, depending on the placement.

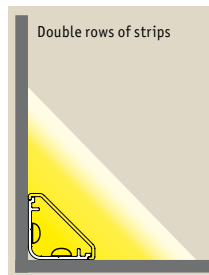
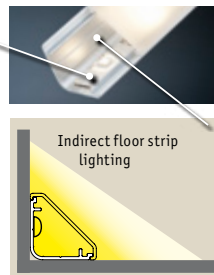
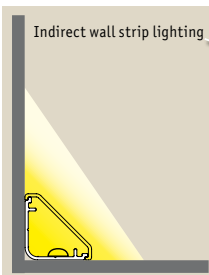

## Innovative designs for decorative room illumination

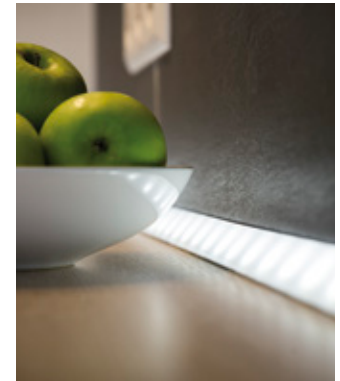
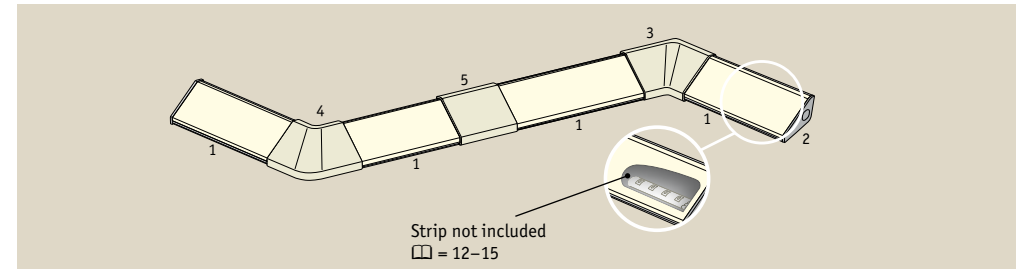

**1** length 1 m and 2 m (cut to any length).  
Incl. diffuser for uniform lighting effects.

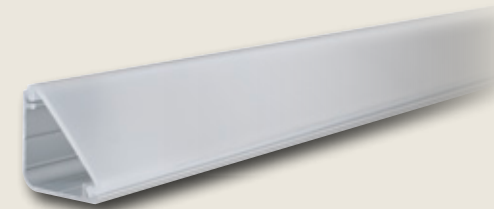

### Delta Profil incl. Diffusor 1m

1×  
⌀20 mm ⌀20 mm ⇄1 m  
🛒 702.62

### Delta Profil incl. Diffusor 2m

1×  
⌀20 mm ⌀20 mm ⇄2 m  
🛒 702.61

**2** End cap



### Delta Profil End Cap

2 pc. set  
⌀20 ⇄8 ⌀20 mm  
🛒 702.66

**3** Inside corner

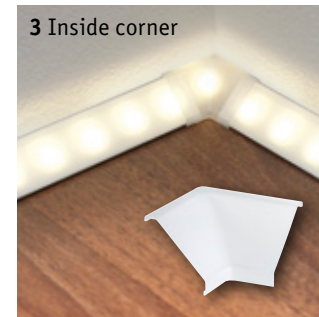

### Delta Profil Inside Corner

2 pc. set  
⌀21 ⇄35 ⌀35 mm  
🛒 702.64

**4** Outer corner



### Delta Profil Outside Corner

2 pc. set  
⌀21 ⇄35 ⌀35 mm  
🛒 702.65

**5** Cover plate



### Delta Profil Cover

4 pc. set  
⌀29 ⇄35 ⌀5 mm  
🛒 702.63

# Floor Profil



## Recessed profile for the floor or the wall

- ▶ Recessed profile for illumination with LED strips creates light accents at the floor, in furniture or other solid materials. Attractive lighting effects at floor transition areas.
- ▶ Can also be used as orientation and guide lights in shadow and danger zones.
- ▶ The supplied diffuser provides uniform light distribution.
- ▶ Can be installed in materials with a thickness of 12 mm or more and can be permanently glued to laminate flooring, tiles and carpets.
- ▶ Imperfect material edges (carpet, laminate flooring, ...) are covered by the profile.
- ▶ The shape of the profile ensures that it does not completely sink into deep grooves. This makes it possible to create additional space when milling grooves in solid materials, for example, for laying cables.
- ▶ Not suitable for installation on floating laminate

## Recessed profile including diffuser

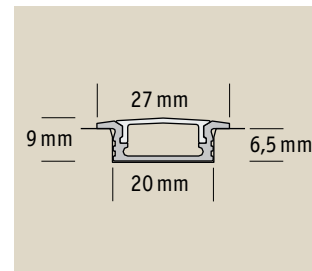
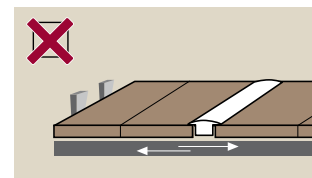
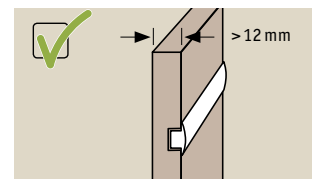
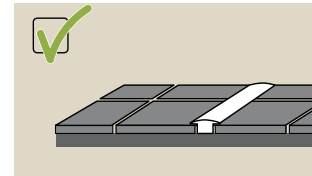
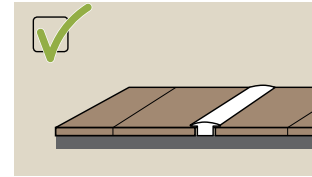

### Floor Profil 2m

1x  
 ⚙ 9 ⇄ 2010 ↻ 27 mm  
 🛒 704.09

### Floor Profil 1m

1x  
 ⚙ 9 ⇄ 1010 ↻ 27 mm  
 🛒 704.10

## Effect lighting



### Digital LED Stripes put colours in motion

- ▶ LED strip set can be shortened electronically and has 164 functions for a range of lighting effects.
- ▶ The digital controller enables colours to be mixed in dynamic rhythms.
- ▶ Can be dimmed and controlled by remote control.
- ▶ Three LEDs per segment can be deactivated starting at the end of the strip. This allows the strip to be installed in a range of locations at the appropriate length.



#### Digital LED Stripe Set 3m

incl. 9,6 W  
165 lm  
230/12 V, 18 VA  
⌀3 mm ⌀10,5 mm ⇄3 m  
🛒 704.81



#### Digital LED Stripe Set 5m

incl. 14 W  
275 lm  
230/12 V, 24 VA  
⌀3 mm ⌀10,5 mm ⇄5 m  
🛒 704.80

## Complete set



### Blacklight Sets – The disco effect for your party with completely new mounting options

- ▶ Innovation for LED Strips: The popular black light effect is also available as an LED strip.
- ▶ Flexible black light layout in places where conventional black light tubes cannot be used, e.g. curved surfaces/counters.
- ▶ Strips can be cut to length every 10 cm.



#### BlackLight LED Stripe-Set 1m

incl. 7,2 W  
230/12 V, 12 VA  
⌀2,5 mm ⌀10,5 mm ⇄1 m  
🛒 703.28



#### BlackLight LED Stripe-Set 3m

incl. 21,6 W  
230/12 V, 22 VA  
⌀2,5 mm ⌀10,5 mm ⇄3 m  
🛒 703.29

Use accessories for flexible mounting  
(☐ = 17)

## USB strips



- ▶ For use with conventional USB ports
- ▶ For decorative auxiliary lighting (keyboards, radios, PC casings and much more)
- ▶ In the colours white, trendy blue, or an attractive red and white mix
- ▶ Glare-free light emission, directed to the side
- ▶ The lights feature adhesive backing for quick and easy, tool-free installation.



#### USB-Stripe Daylight 30cm

incl. 1,5 W  
6000 K  
⌀3 ⇄300 ⌀5 mm  
🛒 704.55



#### USB-Stripe Blue 30cm

incl. 1,5 W  
⌀3 ⇄300 ⌀5 mm  
🛒 704.56



#### USB-Stripe Red/White 30cm

incl. 1,5 W  
⌀3 ⇄300 ⌀5 mm  
🛒 704.57

## YourLED Neon



- ▶ Phosphorescent YourLED DECO LED Stripes with fascinating light effect
- ▶ Useful orientation light even when switched off
- ▶ Afterglow of max. 2 hours
- ▶ For expanding the YourLED DECO basic set
- ▶ Can be combined with YourLED connectors and accessories
- ▶ Plug-in connectors for easy mounting
- ▶ Self-adhesive, flexible; can be shortened in the same way as the well-known YourLED Stripes

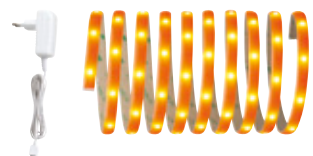

### Basic Set Neon Orange 3m

incl. 7,2 W  
450 lm  
230/12 V, 18 VA  
⌀3 mm ⌀10,5 mm ⇄3 m  
🛒 **705.06**  
*expandable up to 6.25 m*



### DECO Stripe Neon Orange 1m

incl. 2,4 W  
150 lm  
DC 12 V  
⌀3 mm ⌀10,5 mm ⇄1 m  
🛒 **704.31**

## Sets and expansions

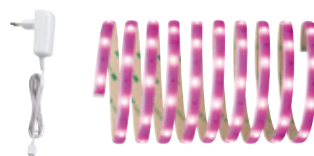

### Basic Set Neon Lilac 3m

incl. 7,2 W  
450 lm  
230/12 V, 18 VA  
⌀3 mm ⌀10,5 mm ⇄3 m  
🛒 **705.05**  
*expandable up to 6.25 m*



### DECO Stripe Neon Lilac 1m

incl. 2,4 W  
150 lm  
DC 12 V  
⌀3 mm ⌀10,5 mm ⇄1 m  
🛒 **704.36**

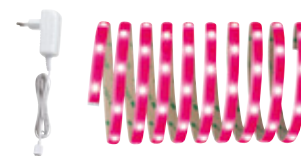

### Basic Set Neon Pink 3m

incl. 7,2 W  
450 lm  
230/12 V, 18 VA  
⌀3 mm ⌀10,5 mm ⇄3 m  
🛒 **705.07**  
*expandable up to 6.25 m*



### DECO Stripe Neon Pink 1m

incl. 2,4 W  
150 lm  
DC 12 V  
⌀3 mm ⌀10,5 mm ⇄1 m  
🛒 **704.84**

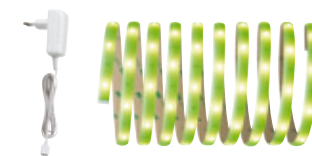

### Basic Set Neon Green 3m

incl. 7,2 W  
450 lm  
230/12 V, 18 VA  
⌀3 mm ⌀10,5 mm ⇄3 m  
🛒 **705.04**  
*expandable up to 6.25 m*



### DECO Stripe Neon Green 1m

incl. 2,4 W  
150 lm  
DC 12 V  
⌀3 mm ⌀10,5 mm ⇄1 m  
🛒 **704.83**

## YourLED Glitter and Glitter Blue

- ▶ YourLED DECO LED Stripes with fascinating glitter light effect
- ▶ Glare-free for use in field of view, thanks to decorative coating and holographic light effects
- ▶ For expanding the YourLED DECO basic set
- ▶ Can be combined with YourLED connectors and accessories
- ▶ Plug-in connectors for easy mounting
- ▶ Self-adhesive, flexible; can be shortened in the same way as the well-known YourLED Stripes
- ▶ Glitter Blue
  - ▶ Phosphorescent YourLED DECO LED Stripes with fascinating glitter light effect
  - ▶ Afterglow of max. 2 hours
  - ▶ Useful orientation light even when switched off

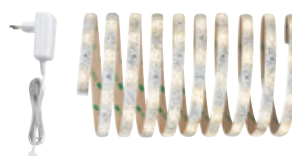
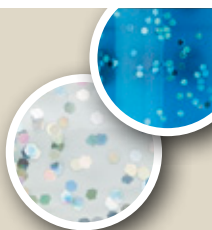

### Basic Set Glitter 3m

incl. 7,2 W  
450 lm, 3000 K  
230/12 V, 18 VA  
⌀3 mm ⌀10,5 mm ⇄3 m  
🛒 **705.02**  
*expandable up to 6.25 m*



### DECO Stripe Glitter 1m

incl. 2,4 W  
150 lm, 3000 K  
DC 12 V  
⌀3 mm ⌀10,5 mm ⇄1 m  
🛒 **704.85**

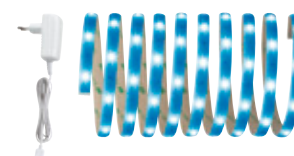

### Basic Set Glitter Blue 3m

incl. 7,2 W  
450 lm  
230/12 V, 18 VA  
⌀3 mm ⌀10,5 mm ⇄3 m  
🛒 **705.03**  
*expandable up to 6.25 m*



### DECO Stripe Glitter Blue 1m

incl. 2,4 W  
150 lm  
DC 12 V  
⌀3 mm ⌀10,5 mm ⇄1 m  
🛒 **704.82**

Use accessories for flexible mounting  
(☐ = 17)





# LED strips and matching profiles

**LED strips by Paulmann – versatile with many advantages**



## **LED: Energy-efficient, long-lasting and eco-friendly**

LED strips do not emit UV or infrared light, do not contain mercury and can be recycled. All strips contain integrated LED lamps of energy class A<sup>++</sup>, A<sup>+</sup>, A. The lamps cannot be changed in the luminaire.



## **Lighting without limits**

Adhesive backing for quick and easy, tool-free installation. The YourLED products by Paulmann are conceived as modules for you to mix and match according to your needs: An uninterrupted length of up to 25 metres is possible.



## **Wide assortment**

In addition to the stimulating daylight white, our LED strips are also available in warm white and as coloured RGB light, featuring a number of dimming levels. Whether individual components or complete sets – we have the individual lighting solution you're looking for.

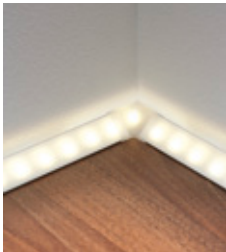

## **Variety of ideas and examples**

Let us spark your imagination – walls begin to glow, furniture seems to levitate. Our Delta Profil and Duo Profil accessories are real eye-catchers: These high-quality mounting solutions make YourLEDs look especially elegant and can be used to create subtle background lighting.

Paulmann Licht GmbH  
Quezinger Feld 2  
31832 Springe / Germany  
[www.paulmann.com](http://www.paulmann.com)