

Nådendal 148

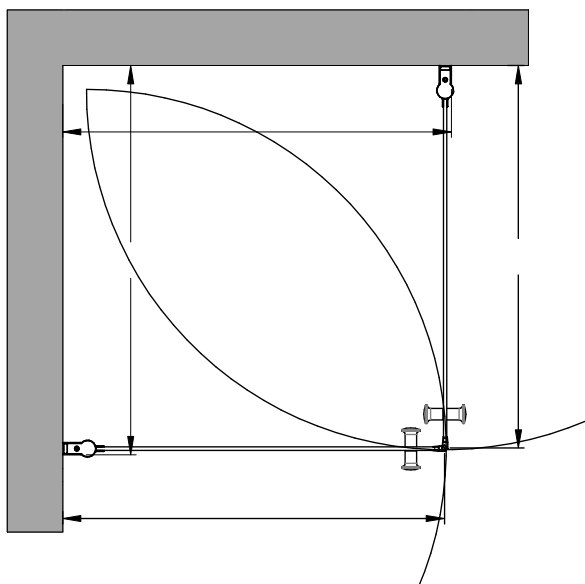

8/25 7DRLM

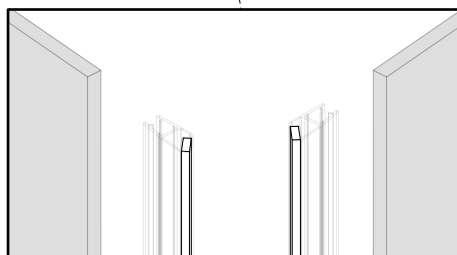
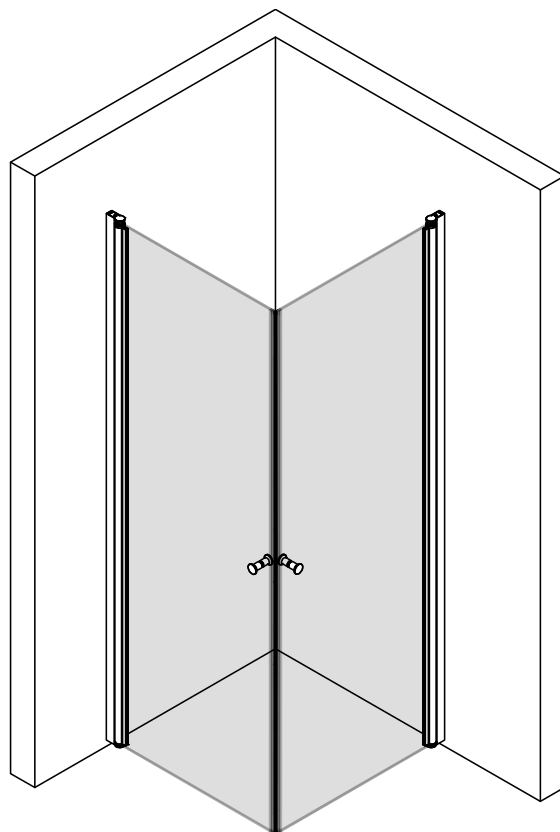

A = 791 / 891

B = 791 / 891

L1 = 803 / 903

L2 = 803 / 903



Nådendal

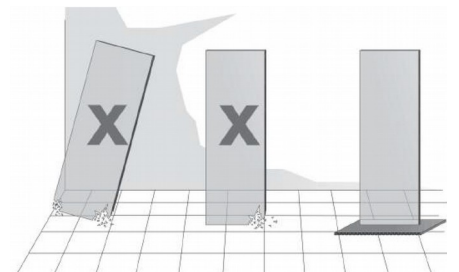
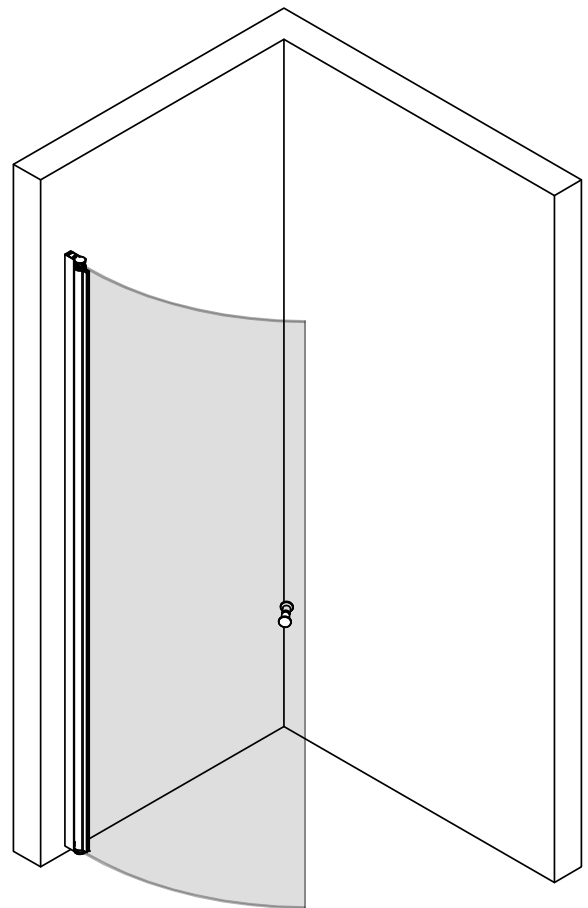
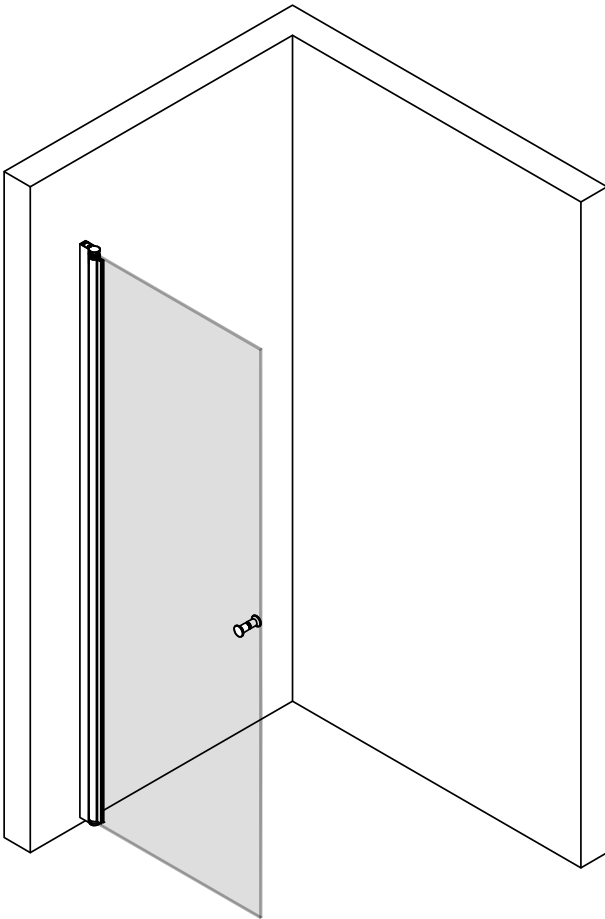

Parts

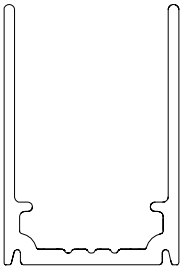

1. x1

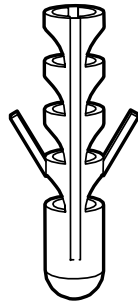

2. 6x30 mm
x4

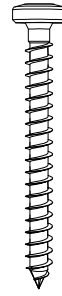

3. 4.5x44 mm
x4

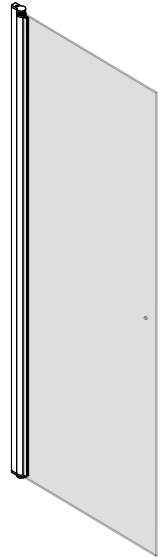

4. x1



5. 4.2x13 mm
x4

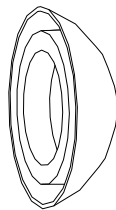

6. x4

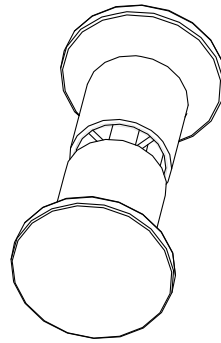

7. x1

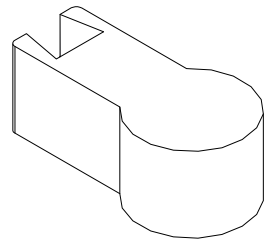

8. x1

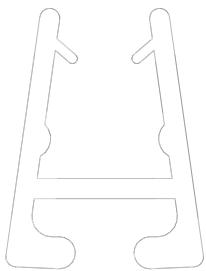

9. x1

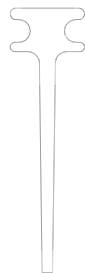

10. x1

Tools

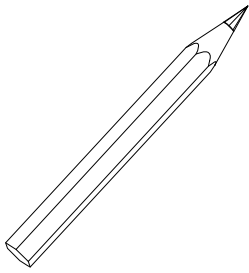

A

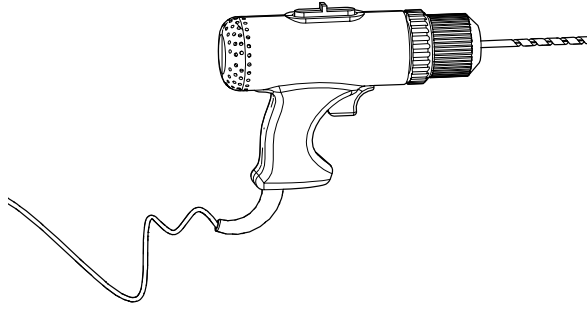

Ø5 mm
Ø6 mm
B



C – Silicone

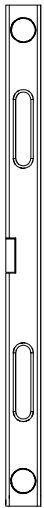

D

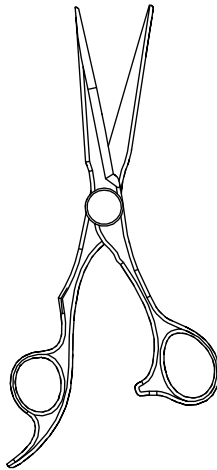

E

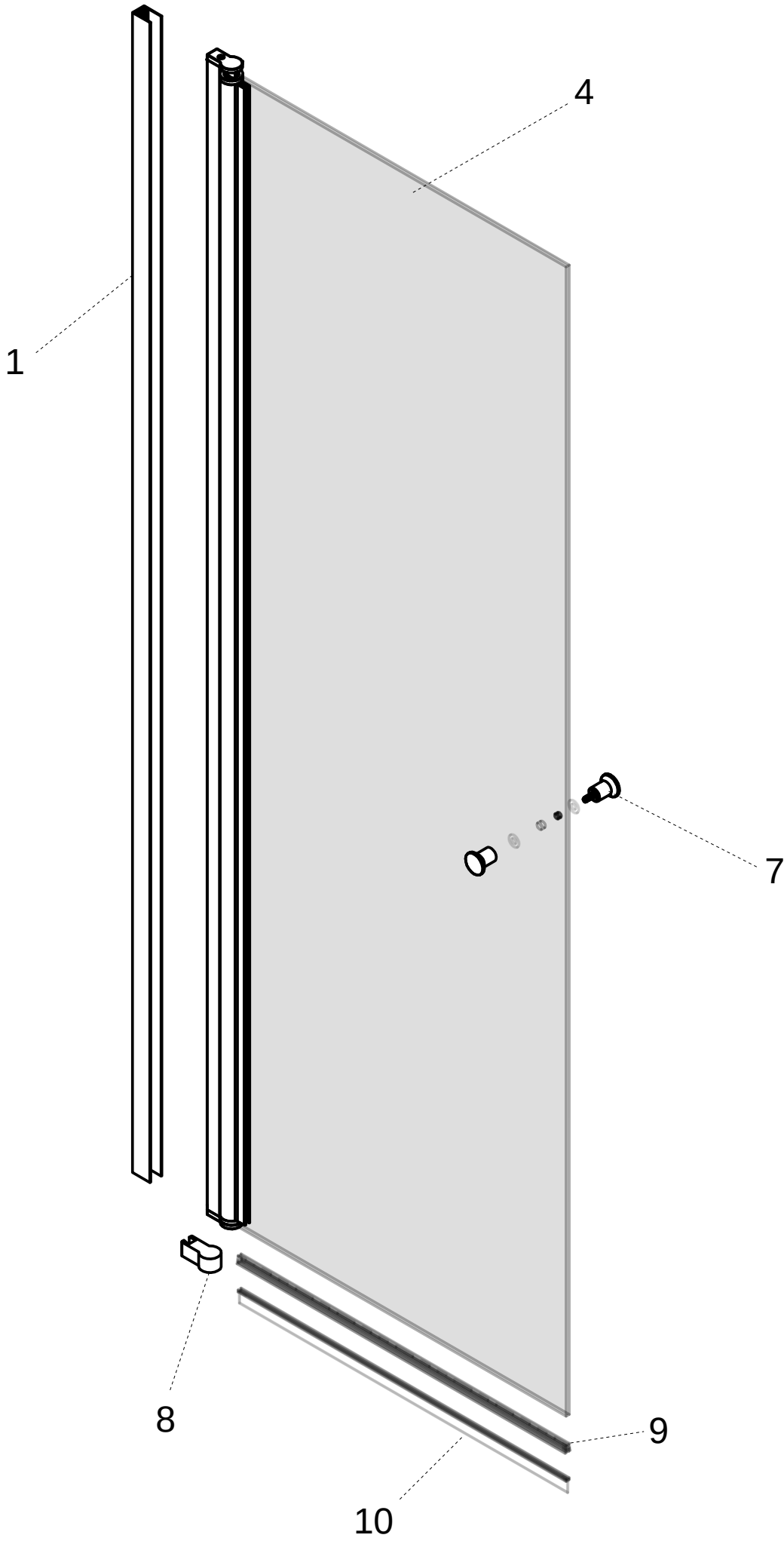

1

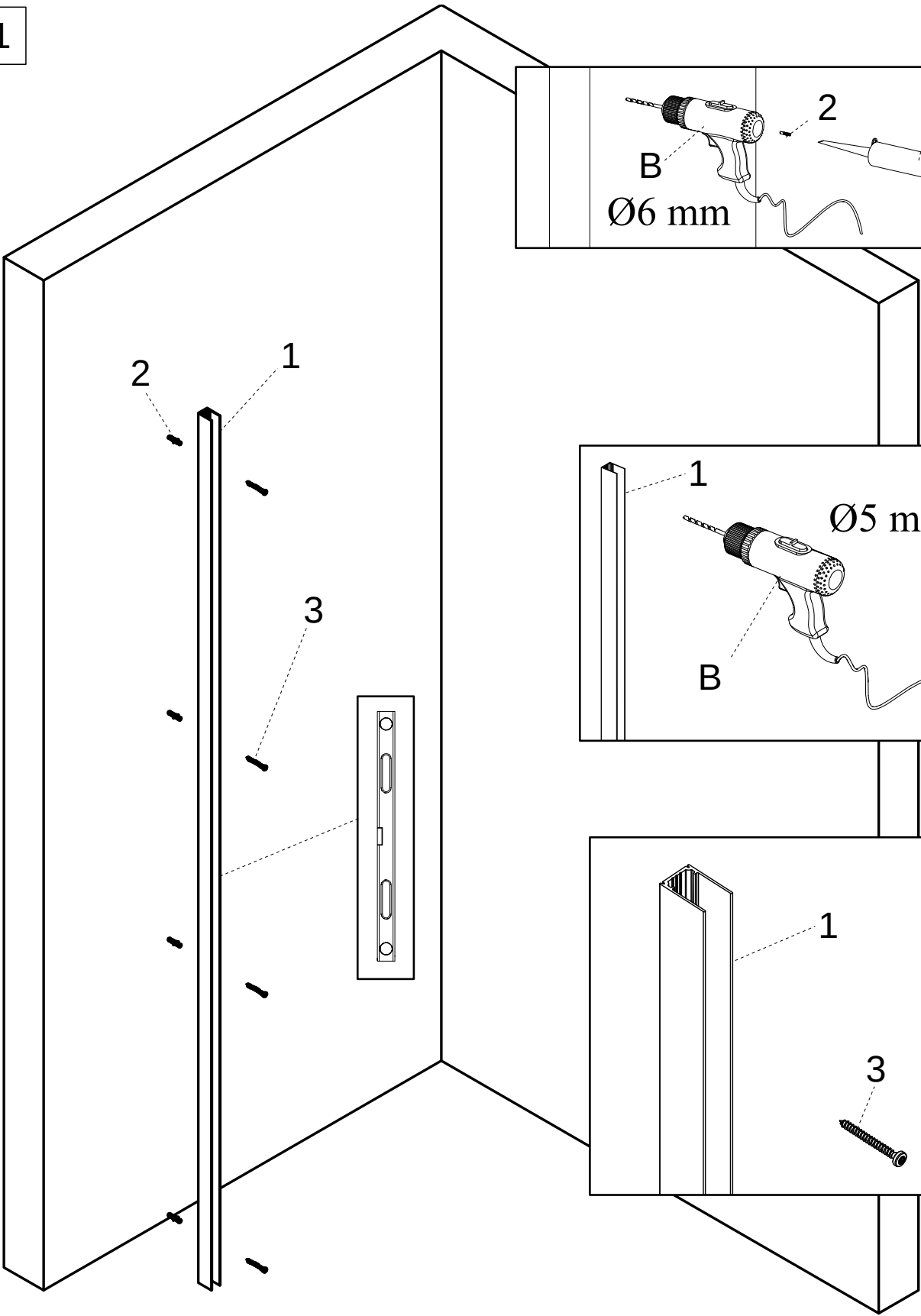
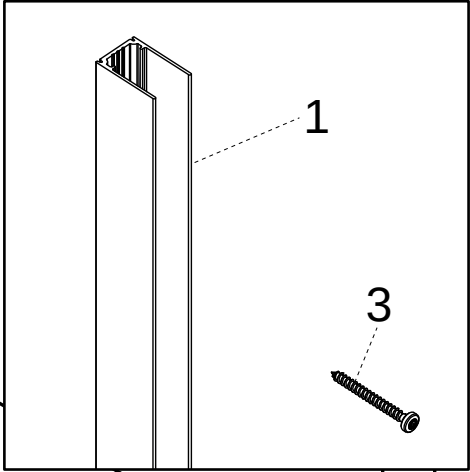
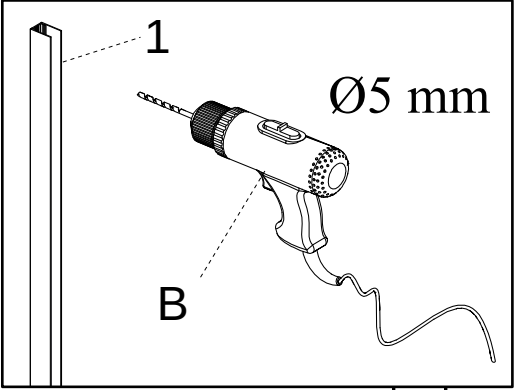
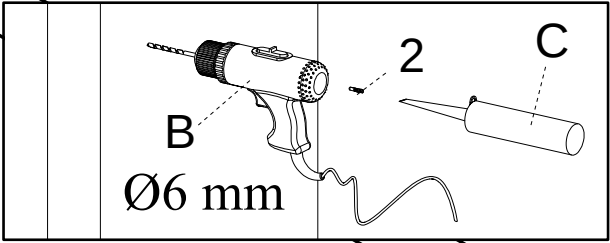

2

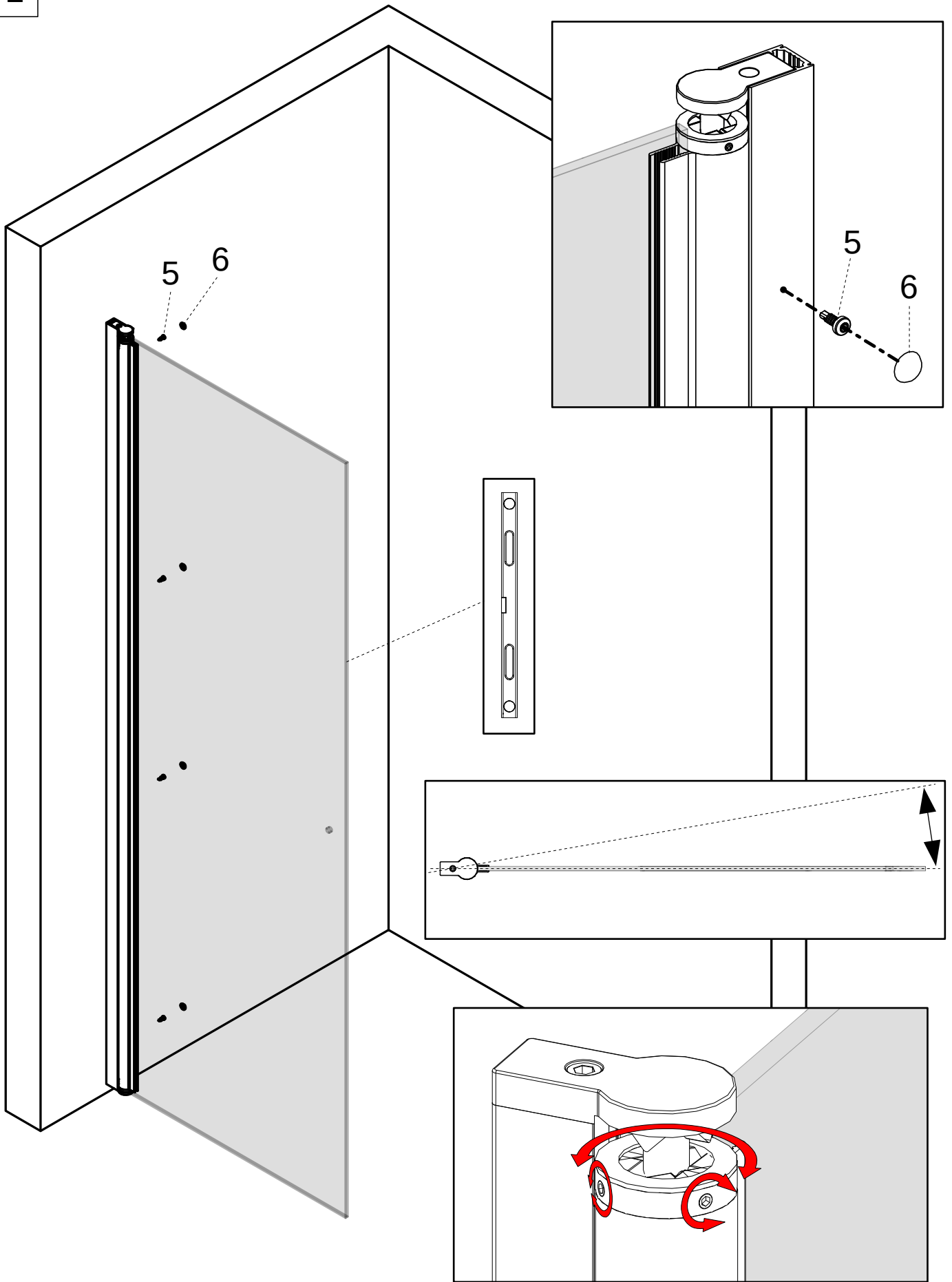

3

