

Linoleum Paneler



Linoleum Paneler

Vores akustikpaneler med linoleumsoverflade giver dig mulighed for at skabe et unikt og personligt præg på din indretning. Med 21 forskellige farvetoner og 2 forskellige lamellbredder kan du let finde et produkt, der opfylder netop dine behov. Linoleum er et eksklusivt og slidstærkt naturmateriale, som giver et moderne og sofistikeret udtryk, og er et stærkt alternativ til de mere traditionelle træsorter.

Udover det stilfulde design har panelerne samme fremragende akustiske egenskaber som vores øvrige produkter, hvilket betyder, at de effektivt bryder og absorberer lydølger og reducerer støjniveauet med op til 50 %. Dette skaber et mere behageligt og støjsvagt miljø, både i hjemmet og på arbejdspladsen. Med deres miljøvenlige Svanemærket-certificering og brug af genbrugsmaterialer i produktionen, er vores linoleumspaneler ikke kun en æstetisk tilføjelse til din bolig, men også et ansvarligt valg, der kombineres med design og funktion.

Med vores Linoleum Paneler får du:

Kreativ frihed

Linoleum Paneler giver dig uendelige muligheder for at skabe dit eget unikke udtryk og design.

Eksklusivt design

Et eksklusivt udseende, produceret med et fokus på æstetik og elegance.

Dansk håndværk

Produceret i Midtjylland, som sikrer høj kvalitetsstandard gennem dansk design og produktion.

Det ansvarlige valg

Efter endt levetid kan panelerne recirkuleres, hvilket understreger vores engagement i ansvarligt design og miljøbevidsthed.

Funktioner:

- **Lokal produktion**
Alle paneler er produceret i Danmark.
- **Attraktiv kvadratmeterpris**
Konkurrencedygtig pris pr. kvadratmeter.
- **Hurtig montering**
Nem og hurtig montage.
- **Minimalt brug af værktøj**
Kræver kun få værktøjer til montage og tilpasning.
- **Letvægtskonstruktion**
Panelerne har en lav vægt, hvilket forenkler håndteringen.
- **Varierede overflademuligheder**
Mulighed for forskellige finér overflader og kerne farver.
- **Slidstærkt naturmateriale**
Linoleum er fremstillet af naturlige materialer, hvor hovedingrediensen er linolie, som udvindes fra hørfrø.
- **Miljøcertificerede materialer**
Linoleum Paneler er certificeret med Svanemærket.
- **Rengøring**
Vores paneler kan let rengøres med en opvredet fugtig klud.









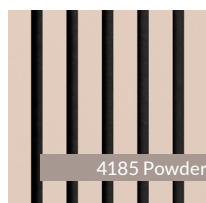
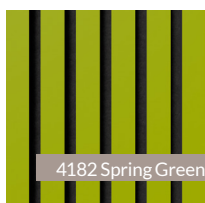
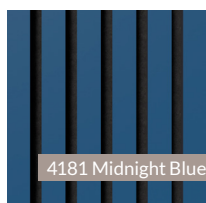
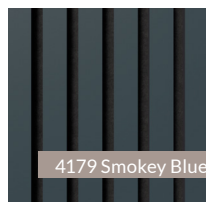
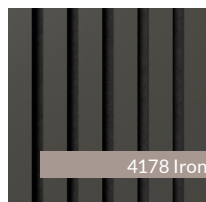
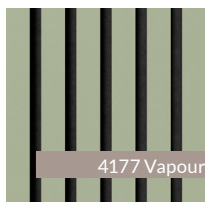
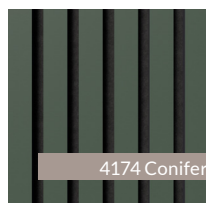
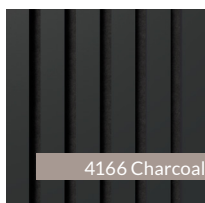
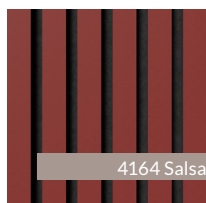
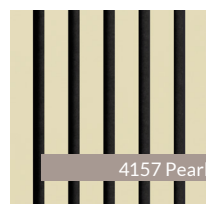
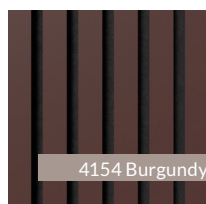
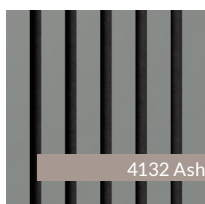
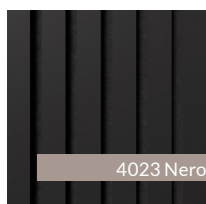



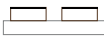





























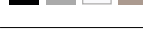

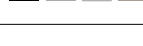



Svanemærket certificeret.



Sorteres som genbrugstræ.



Specifikationer 27 mm







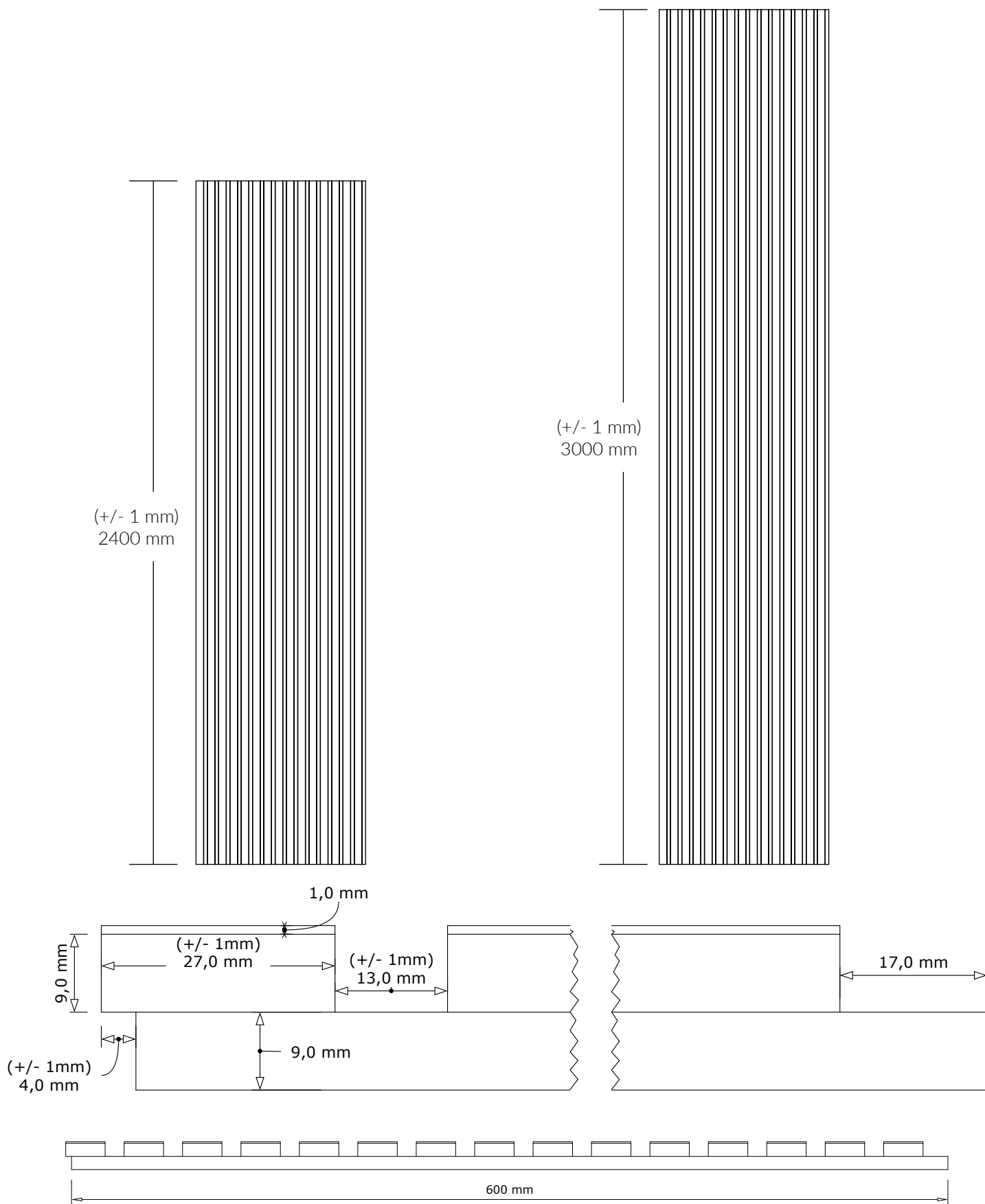



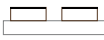





























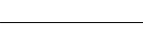





 Finér	 Kerne	 Filt	 Dimensioner	 m ²	 Vægt
4023 Nero			2400 x 600 x 20 mm 3000 x 600 x 20 mm	1,44 1,80	10,3 kg 12,9 kg
4132 Ash			2400 x 600 x 20 mm 3000 x 600 x 20 mm	1,44 1,80	10,3 kg 12,9 kg
4154 Burgundy			2400 x 600 x 20 mm 3000 x 600 x 20 mm	1,44 1,80	10,3 kg 12,9 kg
4155 Pewter			2400 x 600 x 20 mm 3000 x 600 x 20 mm	1,44 1,80	10,3 kg 12,9 kg
4157 Pearl			2400 x 600 x 20 mm 3000 x 600 x 20 mm	1,44 1,80	10,3 kg 12,9 kg
4164 Salsa			2400 x 600 x 20 mm 3000 x 600 x 20 mm	1,44 1,80	10,3 kg 12,9 kg
4166 Charcoal			2400 x 600 x 20 mm 3000 x 600 x 20 mm	1,44 1,80	10,3 kg 12,9 kg
4172 Mauve			2400 x 600 x 20 mm 3000 x 600 x 20 mm	1,44 1,80	10,3 kg 12,9 kg
4174 Conifer			2400 x 600 x 20 mm 3000 x 600 x 20 mm	1,44 1,80	10,3 kg 12,9 kg
4175 Pebble			2400 x 600 x 20 mm 3000 x 600 x 20 mm	1,44 1,80	10,3 kg 12,9 kg
4176 Mushroom			2400 x 600 x 20 mm 3000 x 600 x 20 mm	1,44 1,80	10,3 kg 12,9 kg
4177 Vapour			2400 x 600 x 20 mm 3000 x 600 x 20 mm	1,44 1,80	10,3 kg 12,9 kg
4178 Iron			2400 x 600 x 20 mm 3000 x 600 x 20 mm	1,44 1,80	10,3 kg 12,9 kg
4179 Smokey Blue			2400 x 600 x 20 mm 3000 x 600 x 20 mm	1,44 1,80	10,3 kg 12,9 kg
4180 Aquavert			2400 x 600 x 20 mm 3000 x 600 x 20 mm	1,44 1,80	10,3 kg 12,9 kg
4181 Midnight Blue			2400 x 600 x 20 mm 3000 x 600 x 20 mm	1,44 1,80	10,3 kg 12,9 kg
4182 Spring Green			2400 x 600 x 20 mm 3000 x 600 x 20 mm	1,44 1,80	10,3 kg 12,9 kg
4183 Pistachio			2400 x 600 x 20 mm 3000 x 600 x 20 mm	1,44 1,80	10,3 kg 12,9 kg
4184 Olive			2400 x 600 x 20 mm 3000 x 600 x 20 mm	1,44 1,80	10,3 kg 12,9 kg
4185 Powder			2400 x 600 x 20 mm 3000 x 600 x 20 mm	1,44 1,80	10,3 kg 12,9 kg
4186 Orange Blast			2400 x 600 x 20 mm 3000 x 600 x 20 mm	1,44 1,80	10,3 kg 12,9 kg

Tolerancer

Tolerancer: +/- 1 mm. Vinkelrethed: Længde/bredde +/- 1 mm. Vægt +/- 10%



Specifikationer 40 mm

 Finér	 Kerne	 Filt	 Dimensioner	 m ²	 Vægt
4023 Nero			2400 x 600 x 20 mm 3000 x 600 x 20 mm	1,44 1,80	11,4 kg 14,2 kg
4132 Ash			2400 x 600 x 20 mm 3000 x 600 x 20 mm	1,44 1,80	11,4 kg 14,2 kg
4154 Burgundy			2400 x 600 x 20 mm 3000 x 600 x 20 mm	1,44 1,80	11,4 kg 14,2 kg
4155 Pewter			2400 x 600 x 20 mm 3000 x 600 x 20 mm	1,44 1,80	11,4 kg 14,2 kg
4157 Pearl			2400 x 600 x 20 mm 3000 x 600 x 20 mm	1,44 1,80	11,4 kg 14,2 kg
4164 Salsa			2400 x 600 x 20 mm 3000 x 600 x 20 mm	1,44 1,80	11,4 kg 14,2 kg
4166 Charcoal			2400 x 600 x 20 mm 3000 x 600 x 20 mm	1,44 1,80	11,4 kg 14,2 kg
4172 Mauve			2400 x 600 x 20 mm 3000 x 600 x 20 mm	1,44 1,80	11,4 kg 14,2 kg
4174 Conifer			2400 x 600 x 20 mm 3000 x 600 x 20 mm	1,44 1,80	11,4 kg 14,2 kg
4175 Pebble			2400 x 600 x 20 mm 3000 x 600 x 20 mm	1,44 1,80	11,4 kg 14,2 kg
4176 Mushroom			2400 x 600 x 20 mm 3000 x 600 x 20 mm	1,44 1,80	11,4 kg 14,2 kg
4177 Vapour			2400 x 600 x 20 mm 3000 x 600 x 20 mm	1,44 1,80	11,4 kg 14,2 kg
4178 Iron			2400 x 600 x 20 mm 3000 x 600 x 20 mm	1,44 1,80	11,4 kg 14,2 kg
4179 Smokey Blue			2400 x 600 x 20 mm 3000 x 600 x 20 mm	1,44 1,80	11,4 kg 14,2 kg
4180 Aquavert			2400 x 600 x 20 mm 3000 x 600 x 20 mm	1,44 1,80	11,4 kg 14,2 kg
4181 Midnight Blue			2400 x 600 x 20 mm 3000 x 600 x 20 mm	1,44 1,80	11,4 kg 14,2 kg
4182 Spring Green			2400 x 600 x 20 mm 3000 x 600 x 20 mm	1,44 1,80	11,4 kg 14,2 kg
4183 Pistachio			2400 x 600 x 20 mm 3000 x 600 x 20 mm	1,44 1,80	11,4 kg 14,2 kg
4184 Olive			2400 x 600 x 20 mm 3000 x 600 x 20 mm	1,44 1,80	11,4 kg 14,2 kg
4185 Powder			2400 x 600 x 20 mm 3000 x 600 x 20 mm	1,44 1,80	11,4 kg 14,2 kg
4186 Orange Blast			2400 x 600 x 20 mm 3000 x 600 x 20 mm	1,44 1,80	11,4 kg 14,2 kg

Tolerancer

Tolerancer: +/- 1 mm. Vinkelrethed: Længde/bredde +/- 1 mm. Vægt +/- 10%

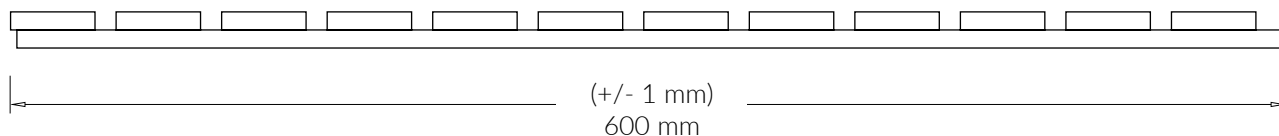
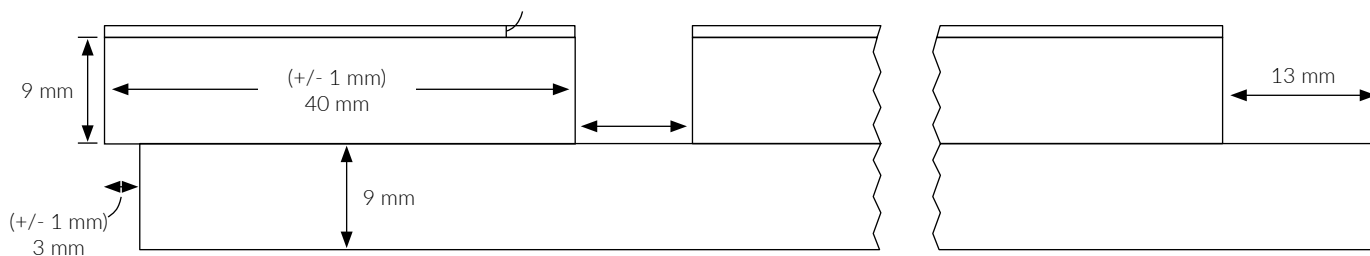
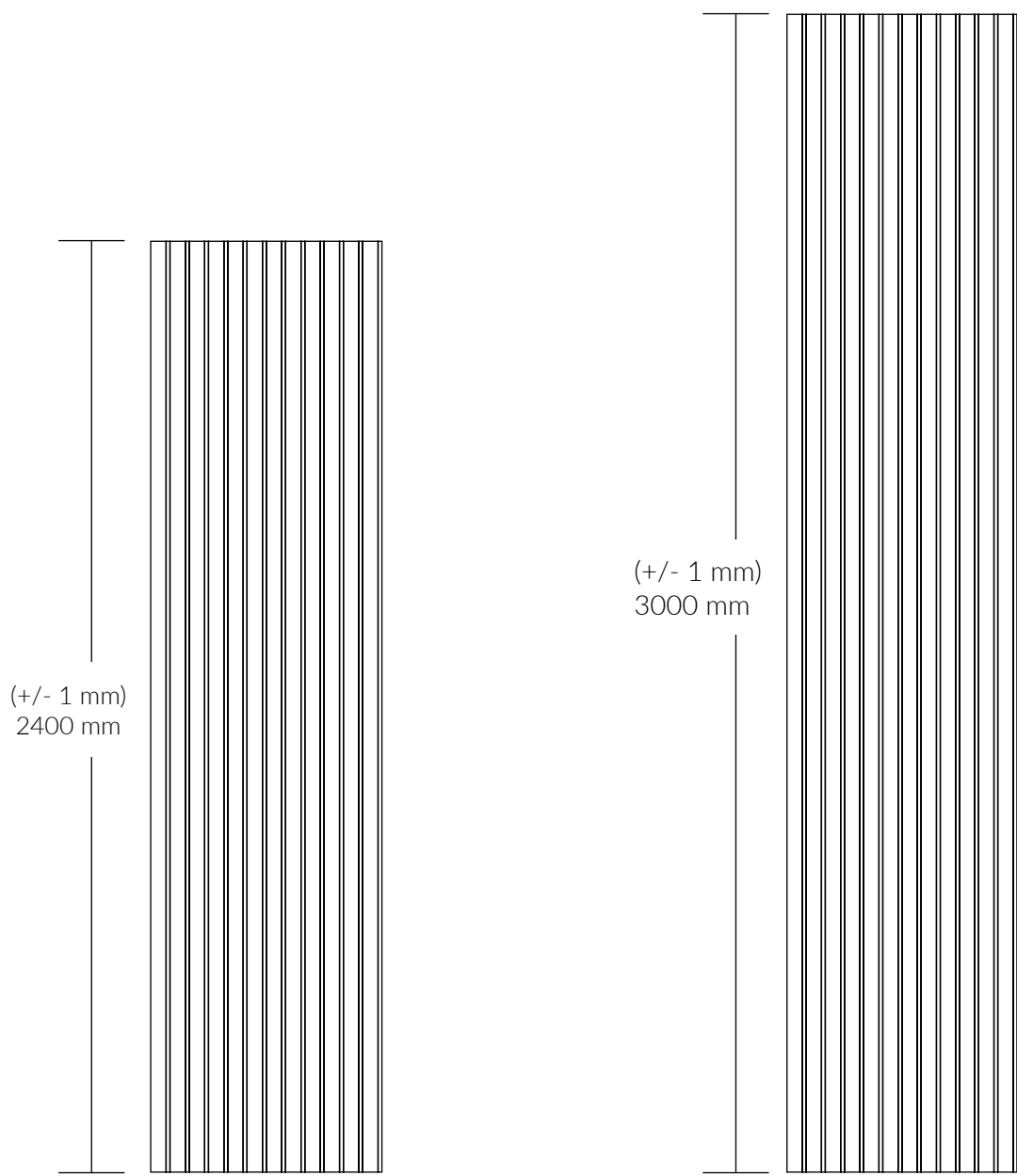

Akustikmålinger

Lydtest iht. DS/EN ISO 354:2003

Lydtest med 45 mm luft bag panelet

Test areal: 10,8 m²
 Rumvolumen: 215 m³
 Rumoverfladeareal: 305 m²

Frequency [Hz]	α_s
100	0.09
125	0.22
160	0.30
200	0.53
250	0.56
315	0.87
400	0.99
500	0.97
630	0.97
800	1.02
1k	1.02
1.25k	0.91
1.6k	0.90
2k	0.87
2.5k	0.80
3.15k	0.81
4k	0.77
5k	0.71

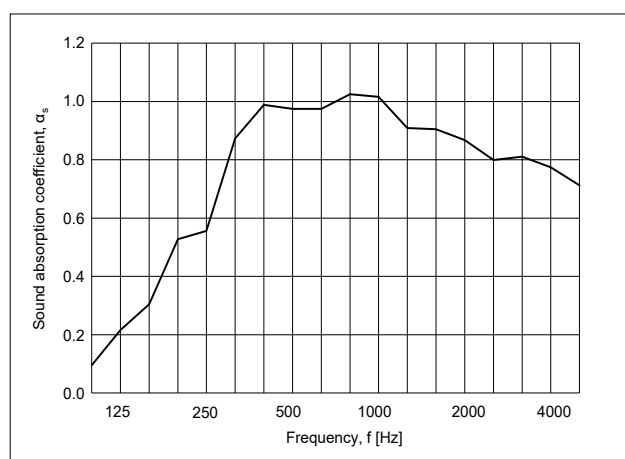

Figur 1: Lydtest monteret med 45 mm luft bag panelet. Lukket ramme omkring kant.

Lydtest med montage direkte på væggen

Test areal: 10,8 m²
 Rumvolumen: 215 m³
 Rumoverfladeareal: 305 m²

Frequency [Hz]	α_s
100	0.02
125	0.02
160	0.02
200	0.05
250	0.05
315	0.11
400	0.16
500	0.26
630	0.32
800	0.46
1k	0.63
1.25k	0.78
1.6k	0.97
2k	1.11
2.5k	1.05
3.15k	0.88
4k	0.75
5k	0.68

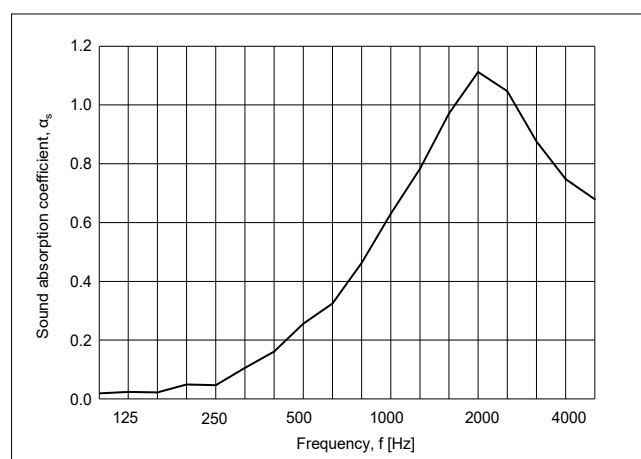

Figur 2: Lydtesten viser montage direkte på væggen.

Test:

Formaldehydetest: Dansk Teknologisk Institut
 Indeklimatest: Dansk Teknologisk Institut
 Akustiktest: Dansk Teknologisk Institut

Montagevejledning

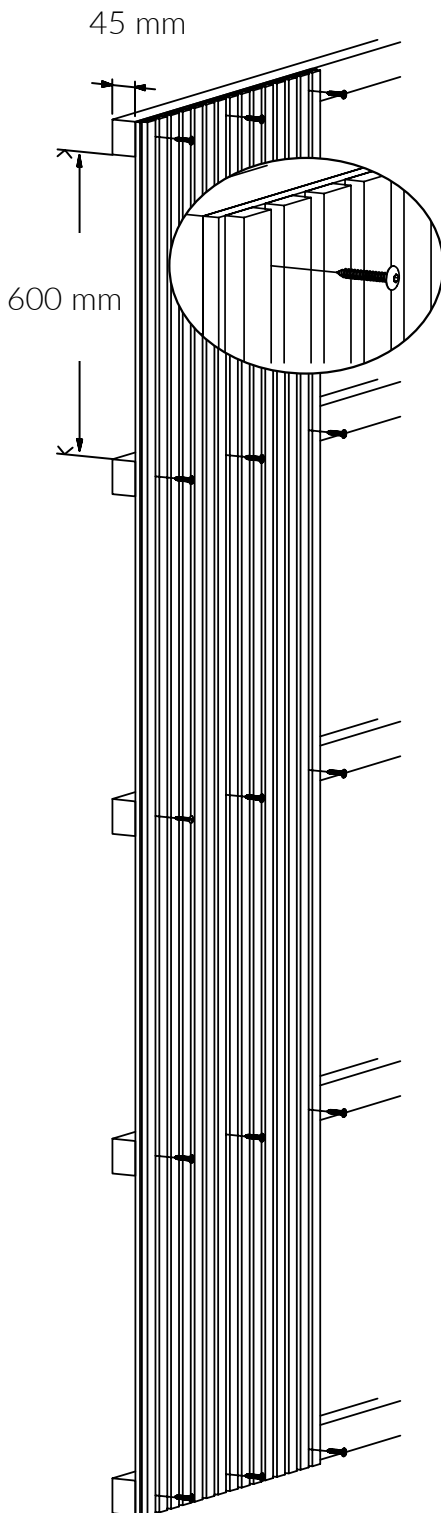

Metode 1

- Direkte på væggen

Monteringslim: Påfør limen på panelet og placer det mod væggen. Sørg for at trykke det fast.

Skruer: Skru panelet gennem filten og ind i væggen. Vi anbefaler at bruge 4 skruer pr. panel. Husk at bruge rawplugs, hvis din vægtype kræver det.

Metode 2

- På en forskalling

For optimal lydabsorption skal du opsætte en forskalling med 45 mm regler på din væg. Vi anbefaler en indbyrdes afstand på 600 mm mellem dine regler. Indsæt mineraluld mellem reglerne. Skru panelet fast på forskallingen gennem filten.

Tilpasning af panelet:

Hvis du har behov for at tilpasse panelerne i bredden eller længden, anbefaler vi at bruge en dyksav eller rundsav til skæringen.

Alternativ montage:

Sømpistol dykker





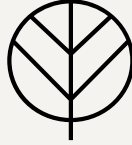

FOG & VENØ A/S

Fog & Venø er en førende dansk producent af akustik- og udsmykningspaneler med og uden akustiske egenskaber. Disse produkter er designet og fremstillet med fokus på dansk håndværk og en konstant stræben efter høj kvalitet. Panelerne er velegnede til montering både på vægge og lofter.

Fog & Venø har et strategisk samarbejde med verdens førende leverandører af materialer såsom træfinér, linoleum, folie og laminat, hvilket sikrer, at alle Fog & Venø-produkter opretholder en høj standard og et bredt udvalg af muligheder. Det betyder at der konstant er efterklang i rummet, og det er her, at vores akustikpaneler gør en stor forskel.

Vores danskproducerede akustikpaneler bryder lyden og absorberer lydbølgen, så den dør ud, når den rammer panelerne. Det betyder, at lydbølgen bliver elimineret og efterklangstiden bliver forkortet, hvilket vil forbedre indeklimaet og følelsen af velvære i rummet, uanset om det er privat, erhverv eller offentlige byggerier vi taler om.

Kontaktinformation

Fog & Venø A/S
Buntmagervej 5, DK-7490 Aulum
Tlf: (+45) 88 77 83 70
hello@fog-veno.com
www.fog-veno.com