

A x 1

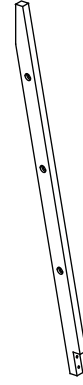

B x 1



C x 1

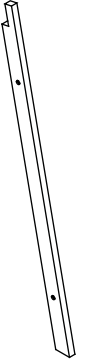

D x 1

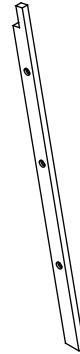

E x 4



F x 2



a x 4



b x 8

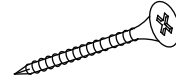

c x 4



d x 1

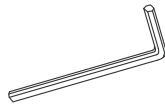

1

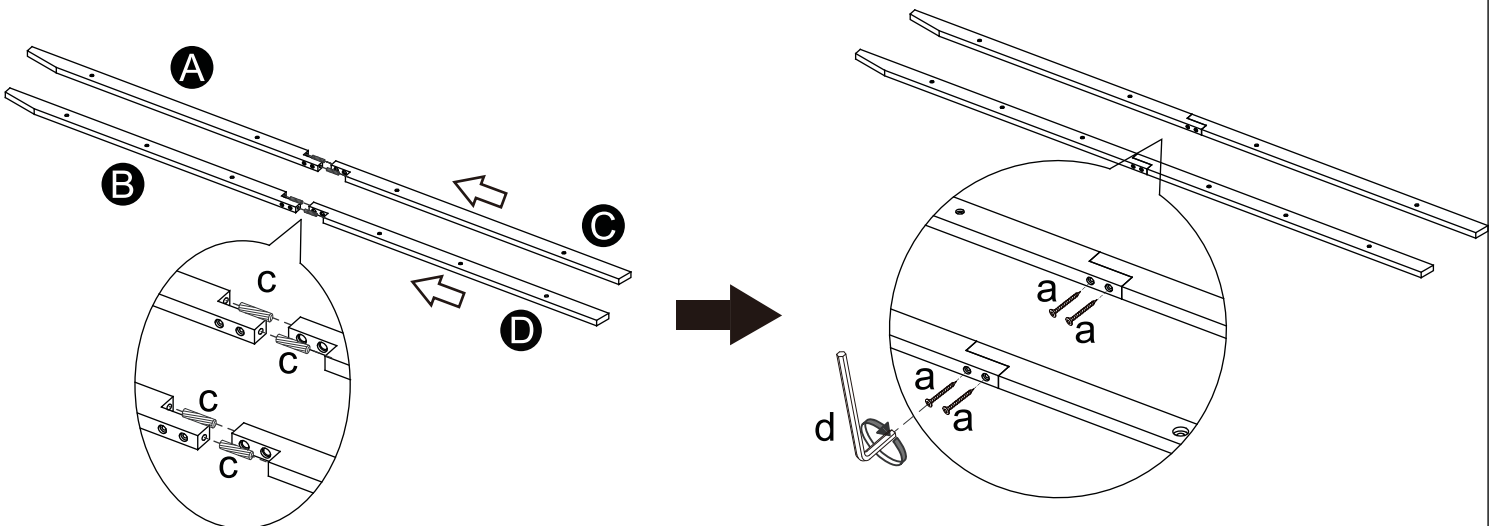

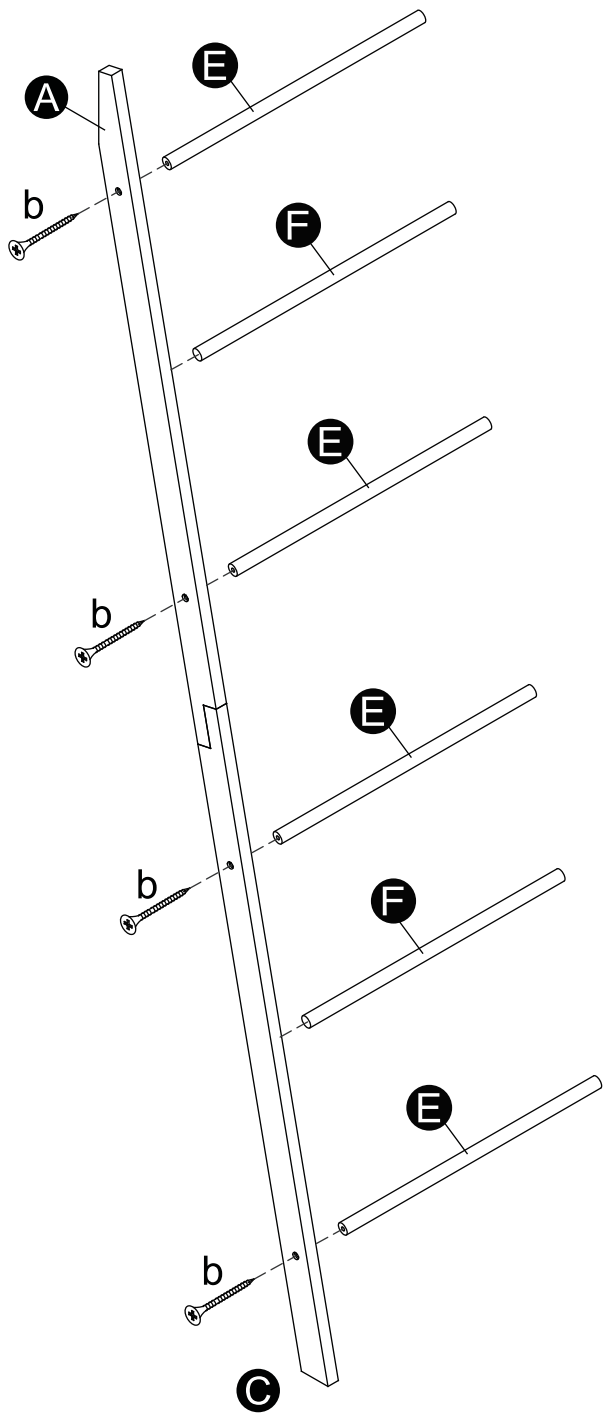
2**3**