

40 min

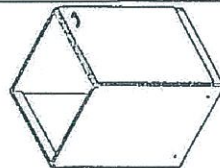

DB 7,8mm x 35mm 10x	KN 7mm x 50mm 8x	IBS 04 mm 1x
Topfband TB 3,5mm x 16mm 2x	S 16 Abdeckkappe 8x	AK 1x
Gleiter + Nagel GN Griff 2x	GR 3,9mm x 25mm (Passend zum Griff) 8x	S 25 2x
Leim LT 1x		

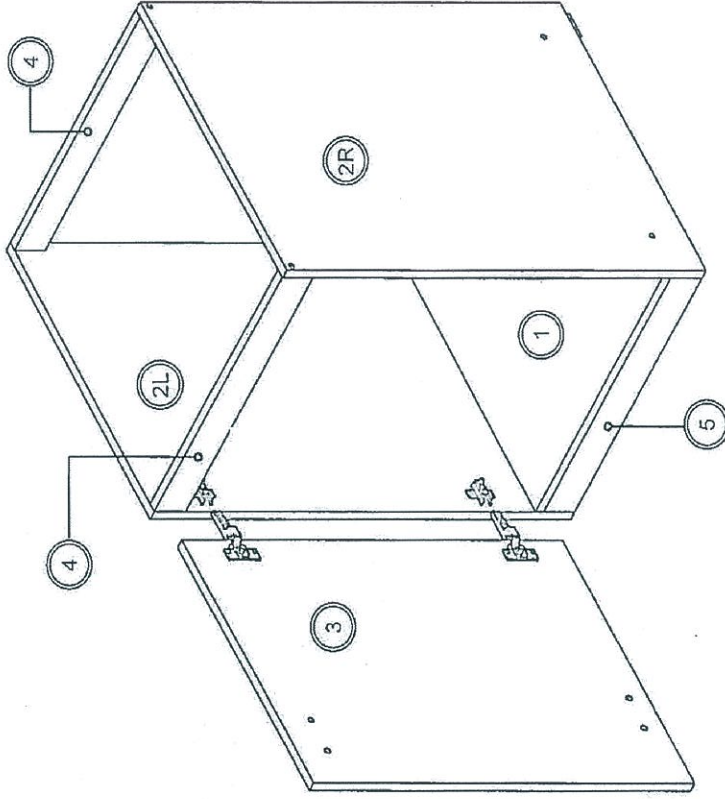

16x488x60
1x
Sockel

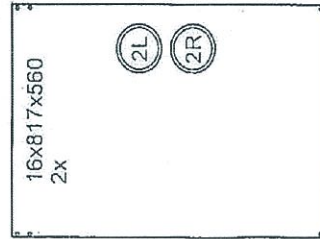

16x488x60
2x
Rückwand

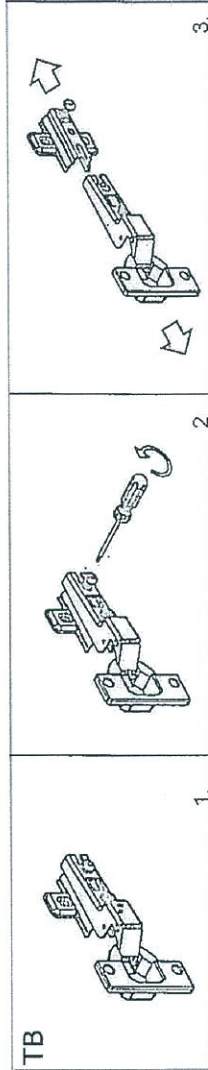

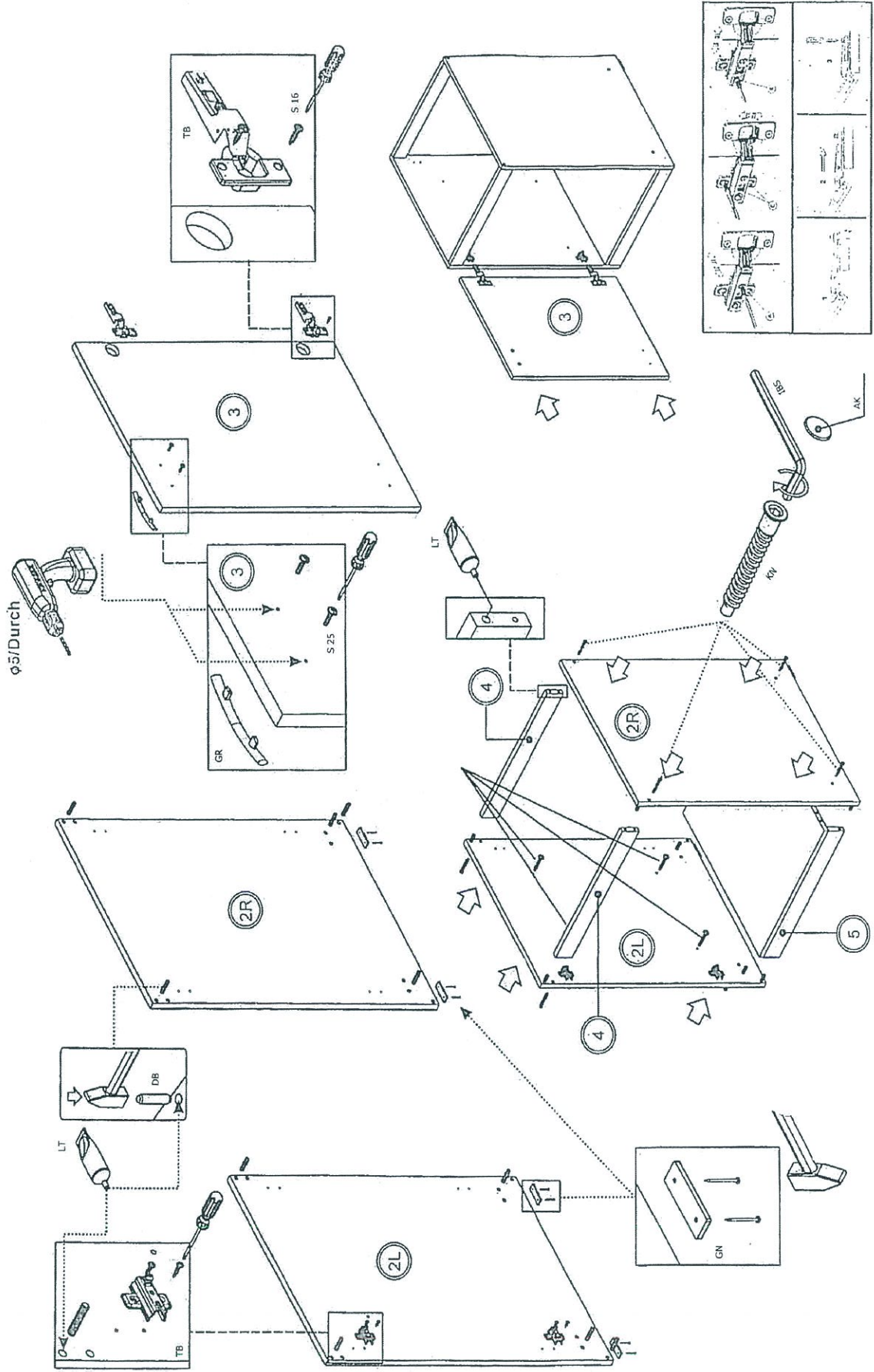

Schritt 1

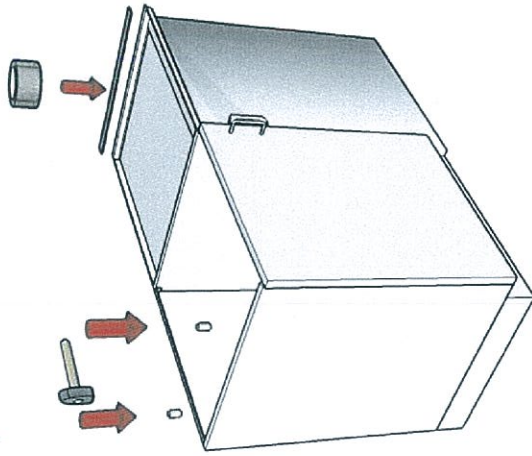

Ø 8mm / Durch

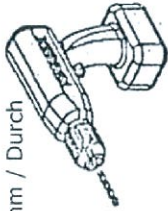

Schritt 2

