

C-C

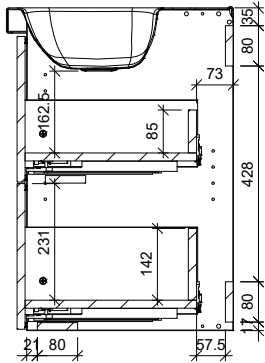

A-A

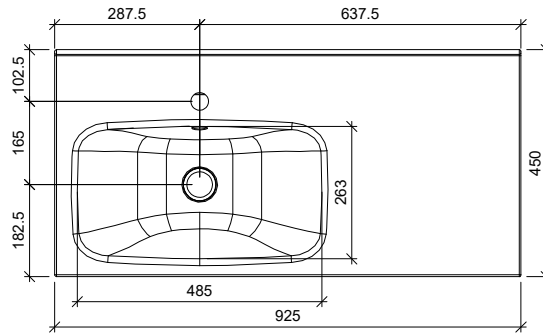

B-B

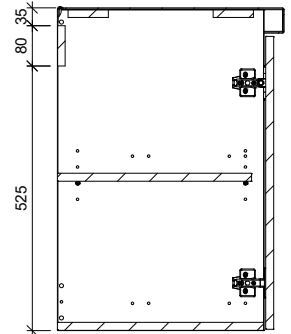

Massa <p style="text-align: center; font-size: 24px;">42.0</p> kg		Mittakaava <p style="text-align: center; font-size: 24px;">1:15</p>		Tuote ALLASKAAPPI Projekti MSLS		STELLA ALLASKAAPPI 2 LTK + SIVUKPI ALLASKUPPI M VASEMMALLA	
Suunn 2023-05-26 JS				TEMAL OY		Ent.	
Tark.				Huoltamotie 3 29250 Nakkila		Uusi	
Hyv.				Puh: 010 217 2300 www.temal.fi		MSLS925450V	