

# INSTRUCTION MANUAL

Model: Paris pendel Ø56

halo  
design

COPENHAGEN

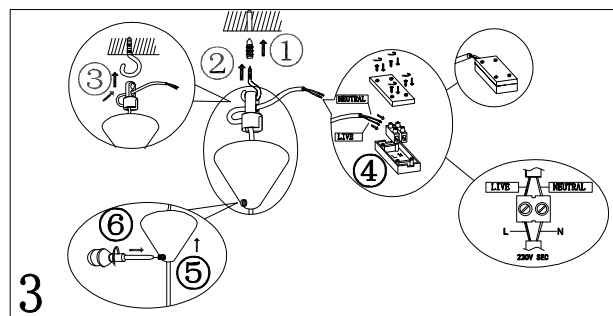
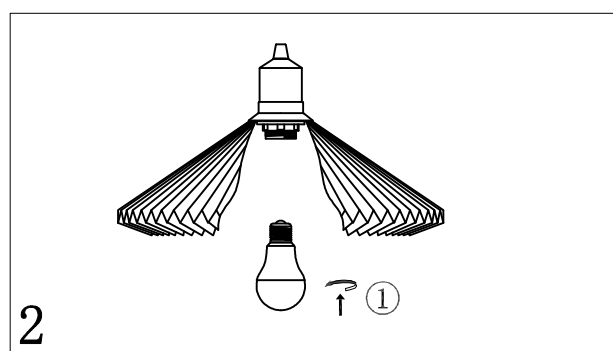
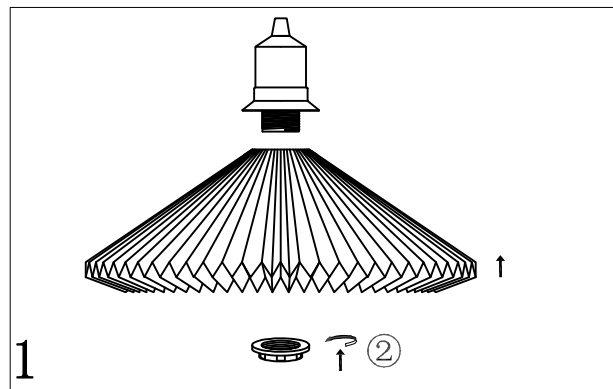
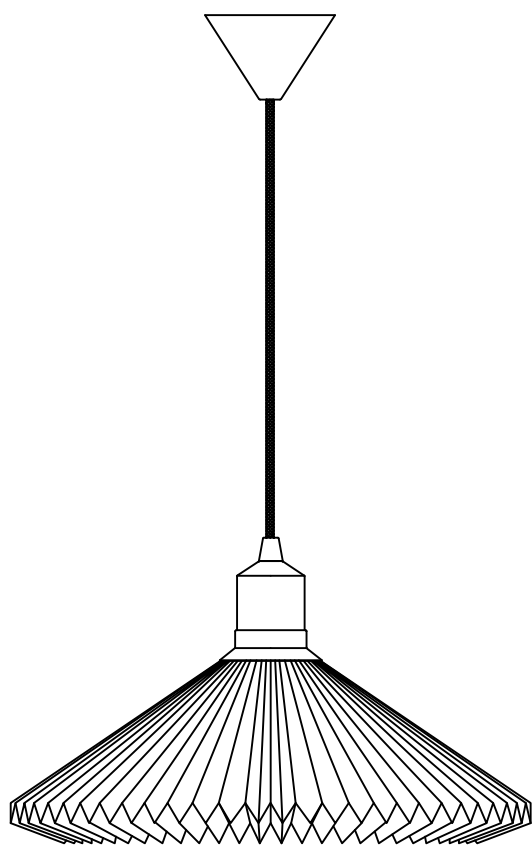

# INSTRUCTION MANUAL

- 1 Follow the instruction sketch.
- 2 Make sure power is OFF on the outlet, before beginning the installation.
- 3 Insert the light bulb.
- 4 Go through point 1 to 3 before connecting the lamp to the power.

230V 1xE27 MAX 60W



Designed by Halo Design, Gammelgårdsvej 85, DK3520 Farum