



DESIGNLIGHT

SCANDINAVIAN AB

MINIDOWNLIGHT, 10-PACK

E-NR: 74 753 39

ART NR: Q-19MW-10

EFFEKT POWER	MATERIAL MATERIAL	KELVIN KELVIN	ARMATURFÄRG ARMATURE COLOR	ANSLUTNING CONNECTION	TOTAL LUMEN	USEFUL LUMEN
10x1,2W	ALUMINIUM	2700K	WHITE	350MA	10x100LM	10x95LM

CE, ROHS, IP CERTIFIED BY SGS  

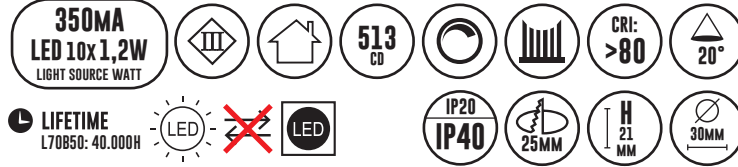

- 2700K
- SNABBKOPPLING
- 10-PACK

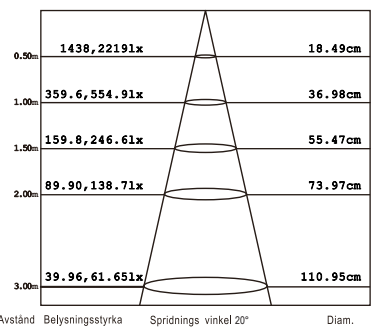
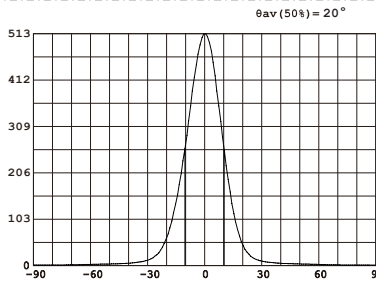
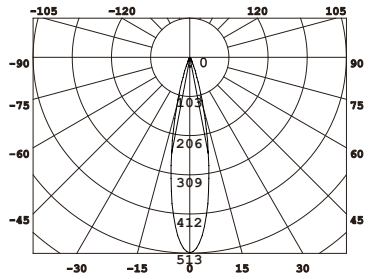

1. Stäng av strömmen/Turn off the power

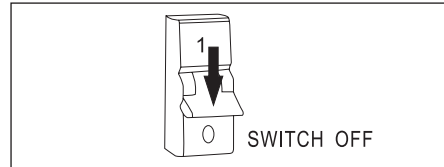

2. Borra hål i taket/Drill hole in ceiling

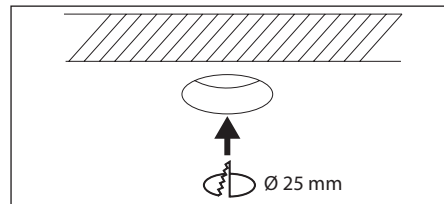

3. Anslut till LED-drivern/Connect to LED driver

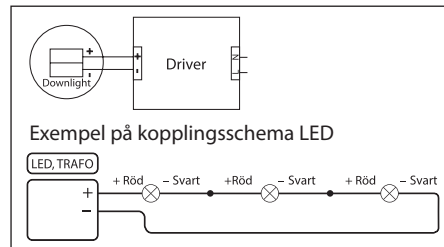

Mått/Dimension

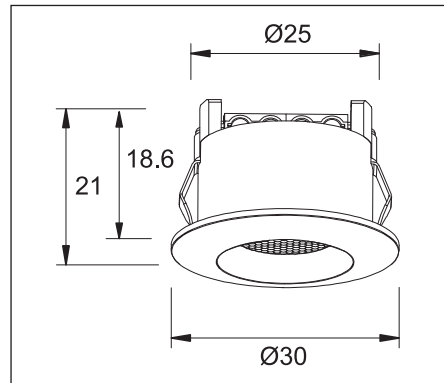

Designlight Scandinavian AB
Q-19MW-10

F

1 kWh/1000h

2019/2015

! SÄKERHET:

1. Läs igenom hela manualen noggrant före installation.
2. Kontrollmät ALLTID diametern före håltagning i tak.
3. Kontrollera att drivdonet är anpassat för det antal lampor som ska installeras. Antal watt per lampa x antalet lampor ger storleken på transformator.
4. Försäkra dig om att spänningen är fränslagen före installation eller underhåll.
5. Installation ska utföras av behörig elektriker.
6. Ljuskällan är ej utbytbar. Hela armaturen måste bytas när ljuskällan är förbrukad.

! SAFETY:

1. Read the entire manual carefully before installation.
2. ALWAYS check the diameter before drilling holes in the ceiling.
3. Check that the drive is adapted to the number of lamps to be installed. Number of watts per lamp x number of lamps gives the size of transformer.
4. Make sure that the power is switched off before installation or maintenance.
5. Installation must be performed by a qualified electrician.
6. The light source of this luminaire is not replaceable, when the light source reaches its end of life the whole luminaire shall be replaced.

1.900K	2.700-3.000K	4.000-4.500K	4.800K	5.000-5.000K	7.000-7.500K	10.000K
STEARINLJUS CANDLE	VARMVIT WARM WHITE	NATURLIG VIT NATURAL WHITE	SOLLJUS DIRECT SUN	VITT DAGSLJUS DAY WHITE	KALLVIT COOL WHITE	BLÅ HIMMEL BLUE SKY

DESIGNLIGHT
SCANDINAVIAN AB

DESIGNLIGHT SCANDINAVIAN AB · TOFFELVÄGEN 1 · 342 60 MOHEDA
KUNDCENTER: TELEFON 0472-716 10 · FAX 0472-716 09 · INFO@DESIGNLIGHT.NU · WWW.DESIGNLIGHT.NU