













- ① 1x  
- ② 1x   
- ③ 1x   
- ④ 2x  
- ⑤ 2x  





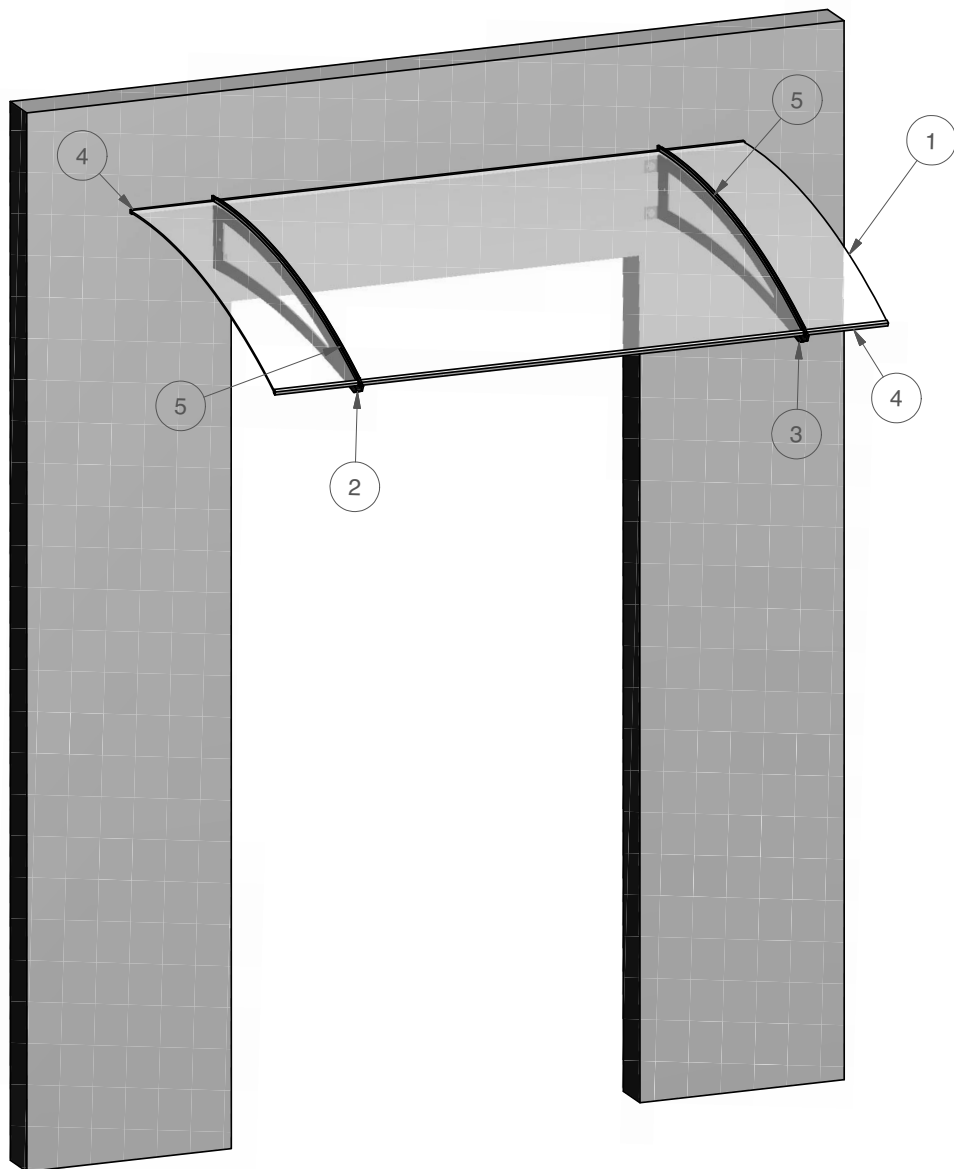
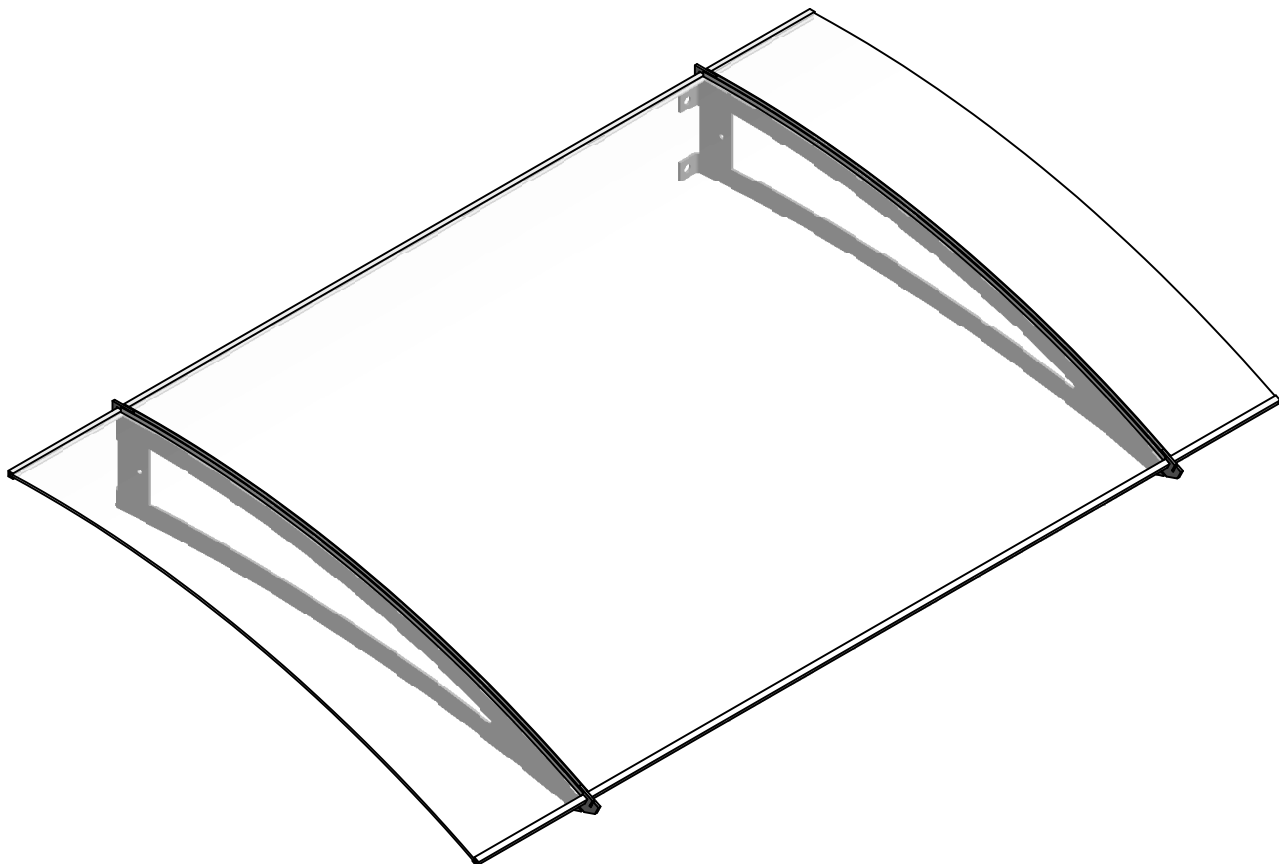
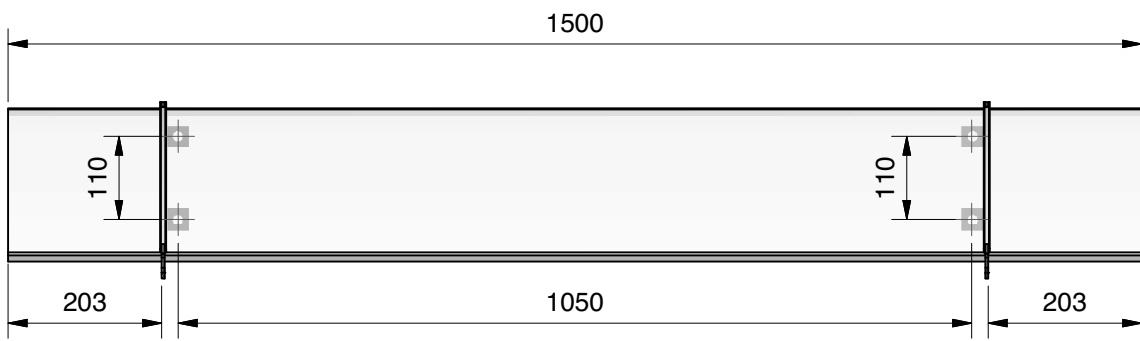
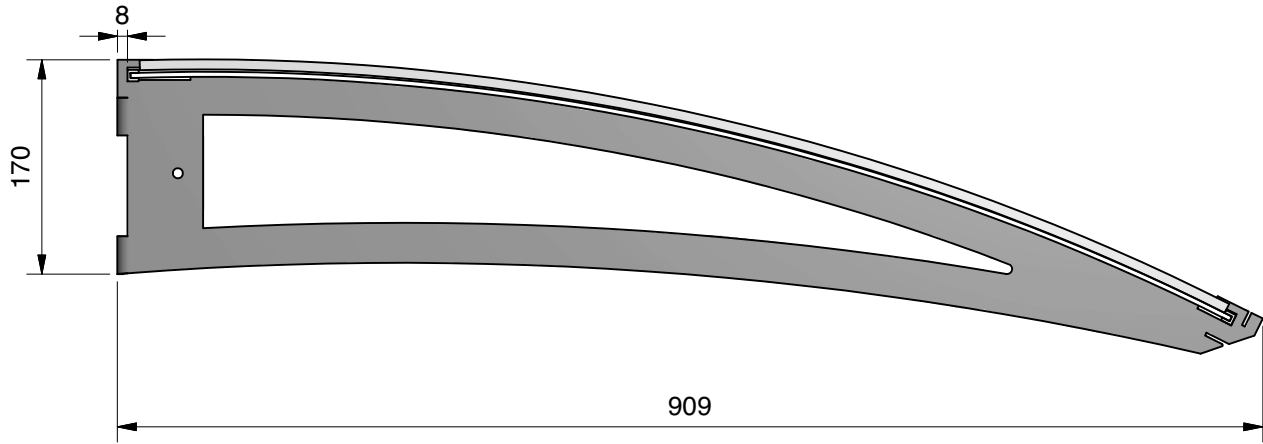

1 x

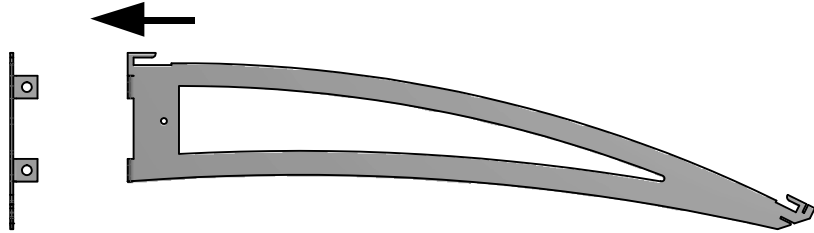

1 x

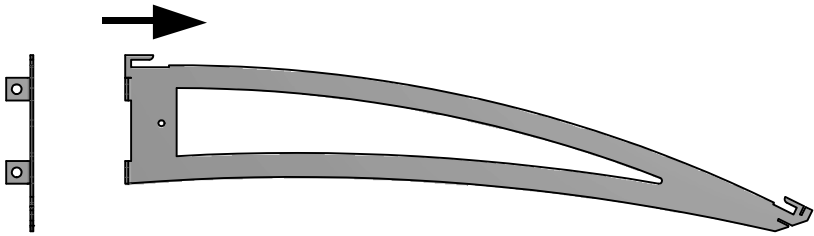



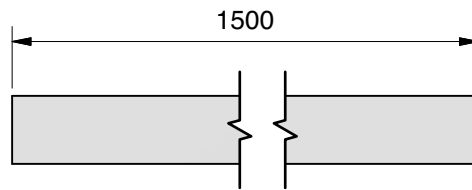

2x

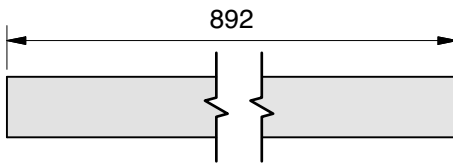

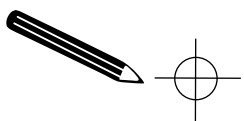



2x

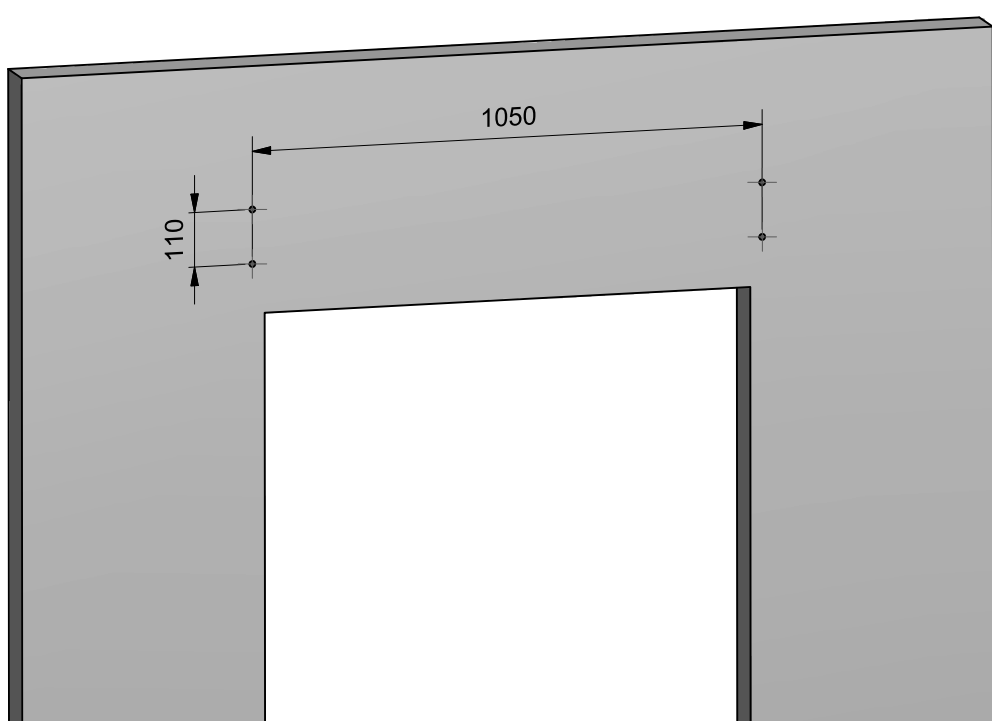
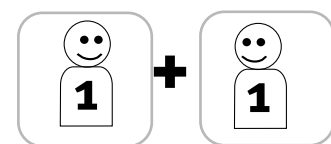

1. 
2.    

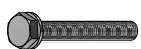

3.     

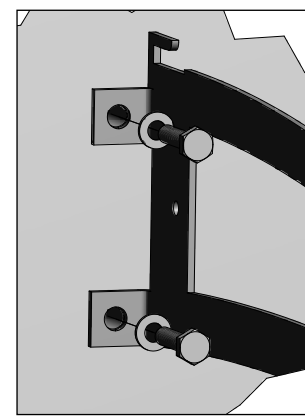
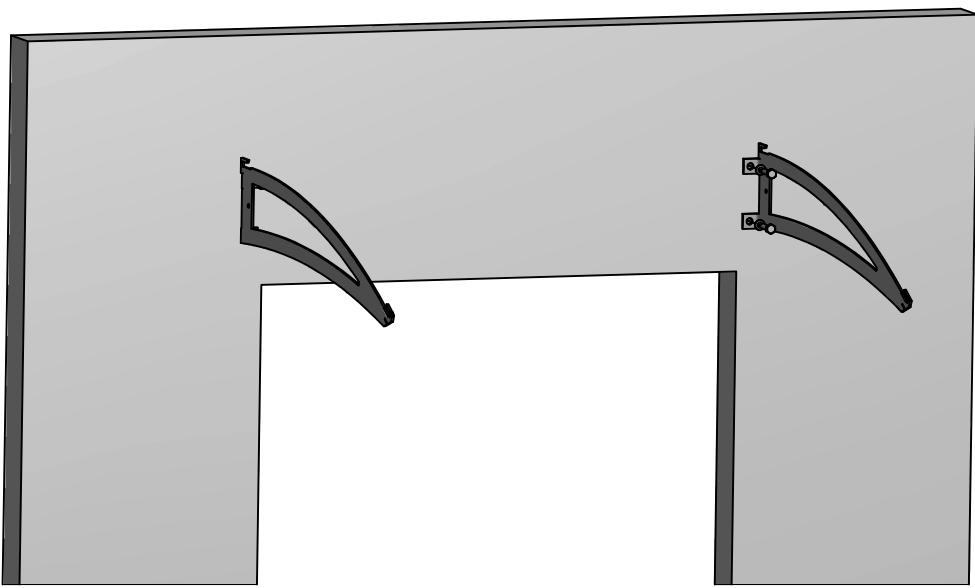

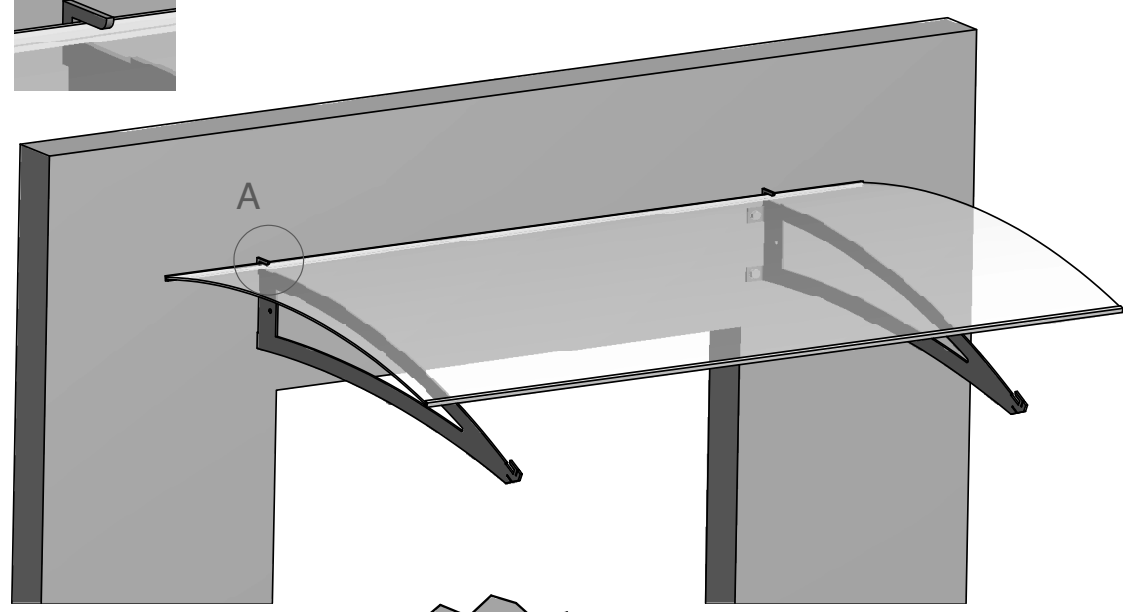
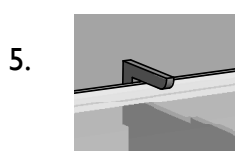
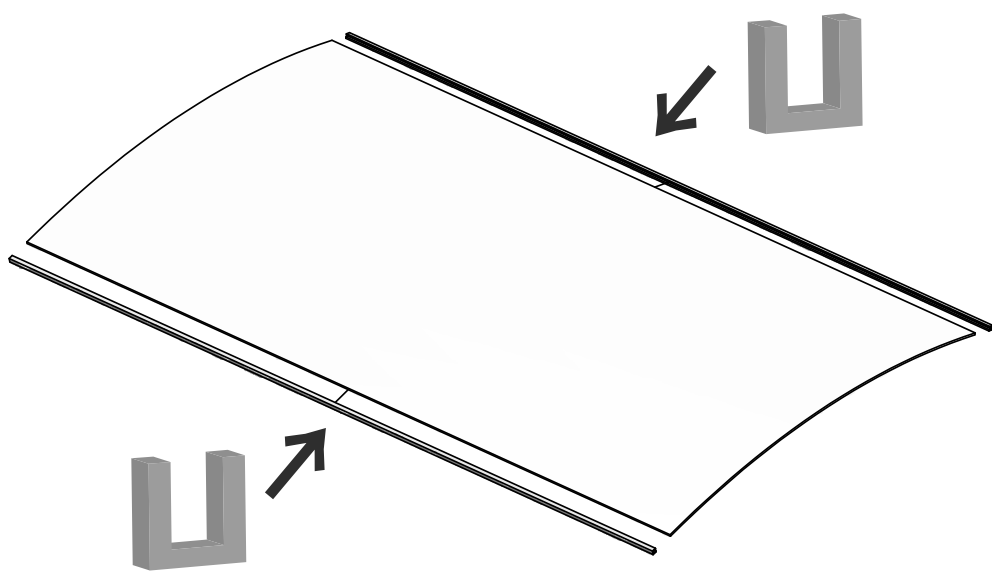

A (1:3)

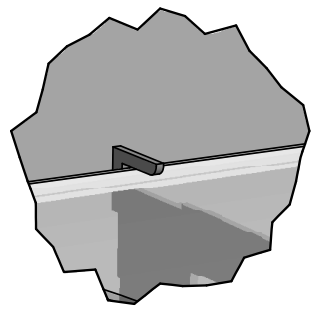

6.

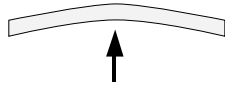

7.

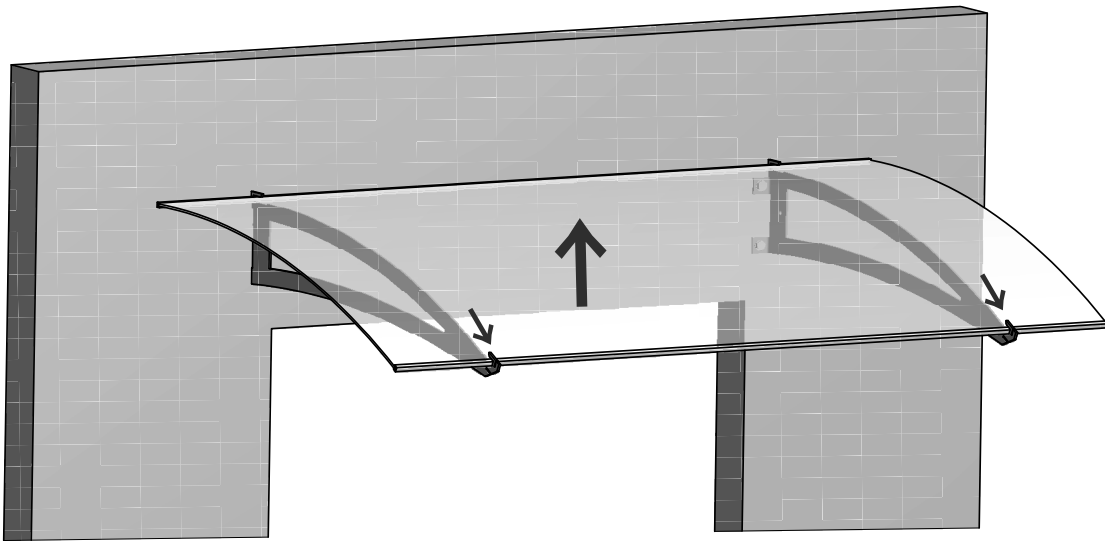
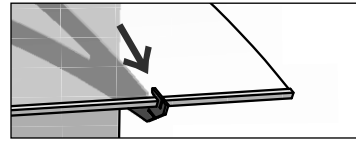
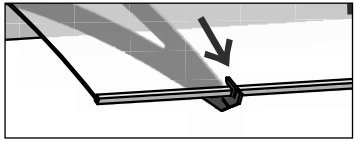

8.

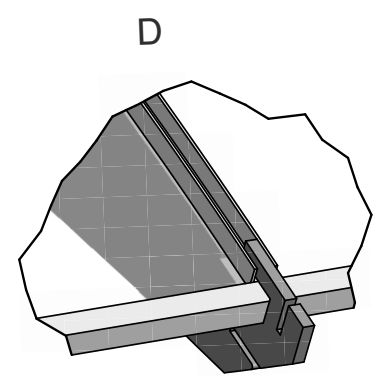
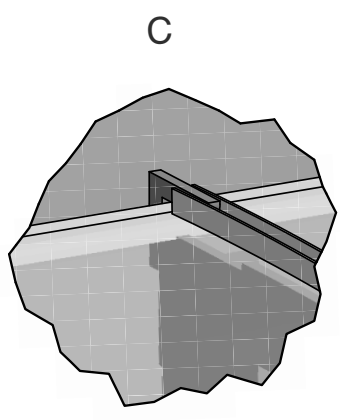
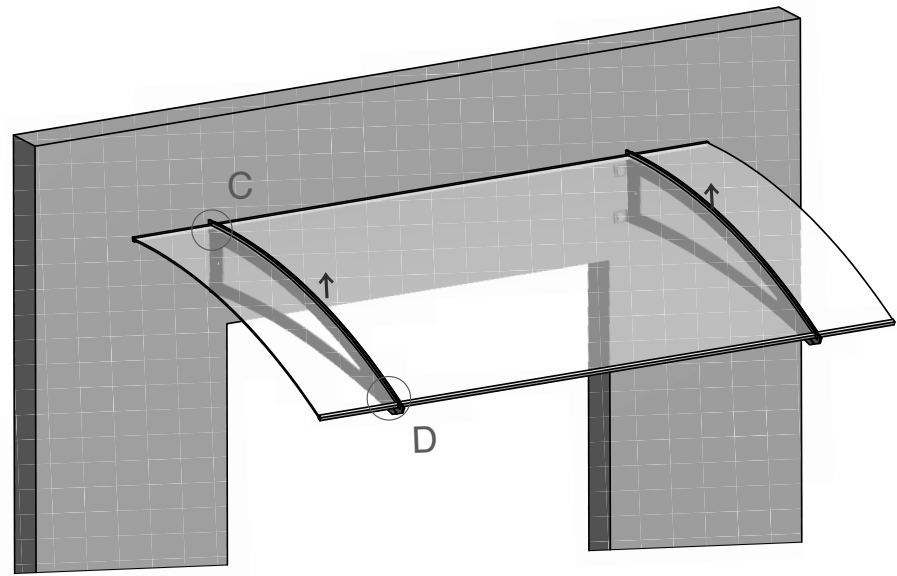
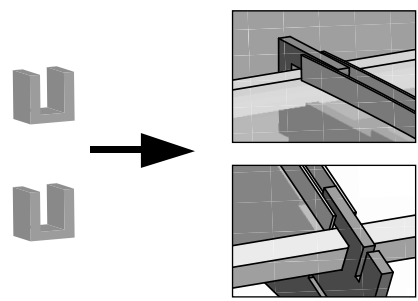

Art.-Nr.: P14-10-04P Irrtümer und technische Änderungen vorbehalten. Stand: August 2011