

DESCRIPTION

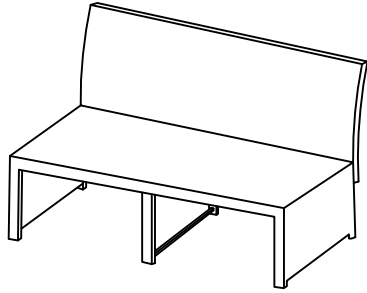





ASSEMBLY INSTRUCTIONS

Hubbi balcony set

Step 1

HARDWARE

No.	Item	Detail	Quantity
1	X		x6
2	Y		x1
3	L1	 M6x40mm	x6
4	A		x1
5	B		x1

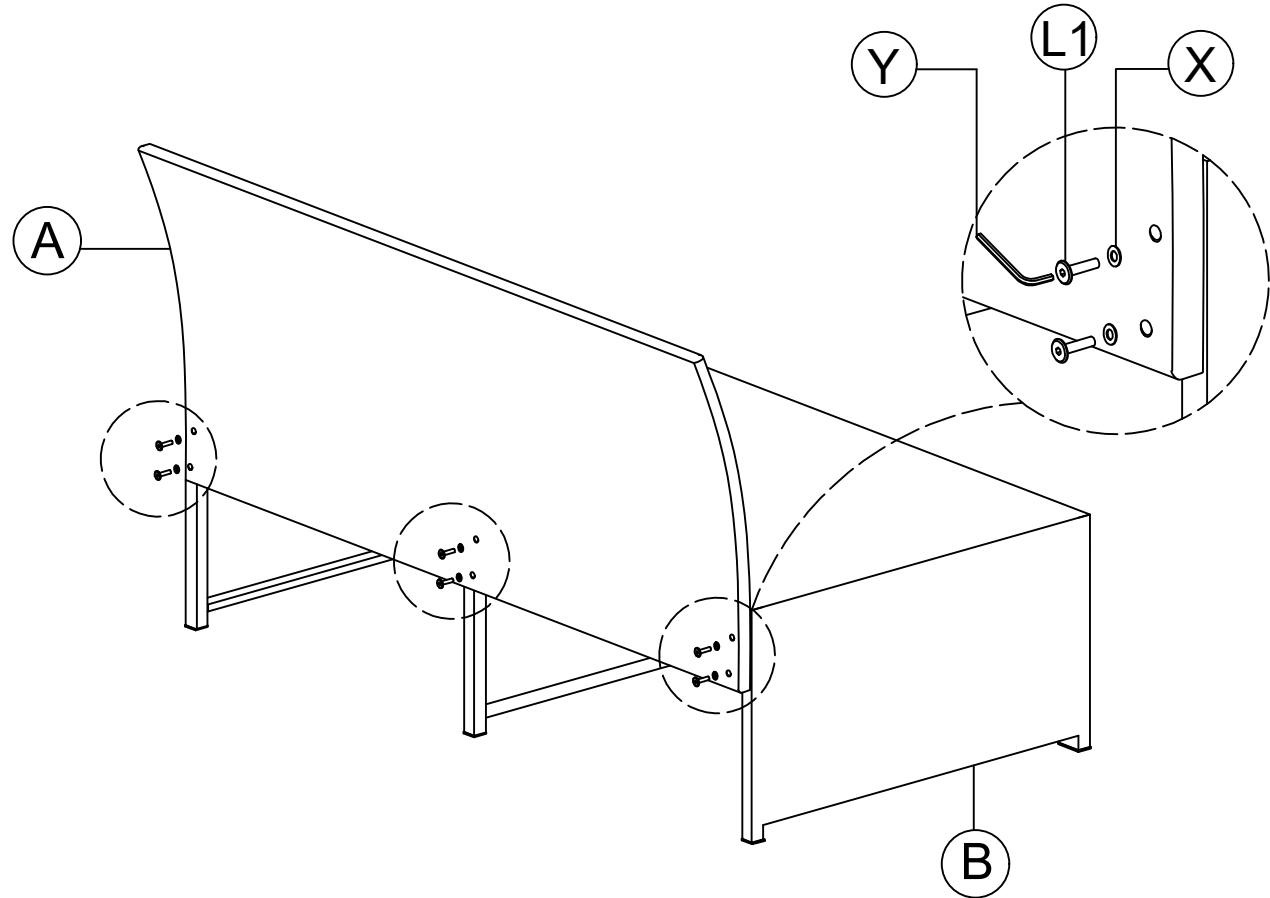

IMPORTANT NOTE:

Do not tighten all screws/bolts until all completely assembled.
Thank you.