

A x1



B x4



C x2



D x24



E x24



F x24

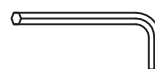

G x1

1

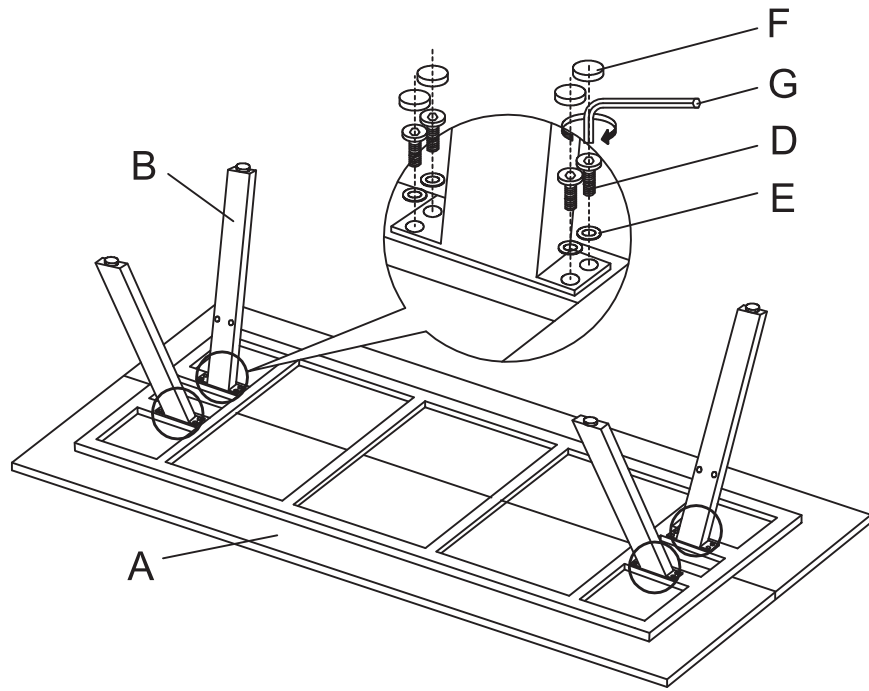

2

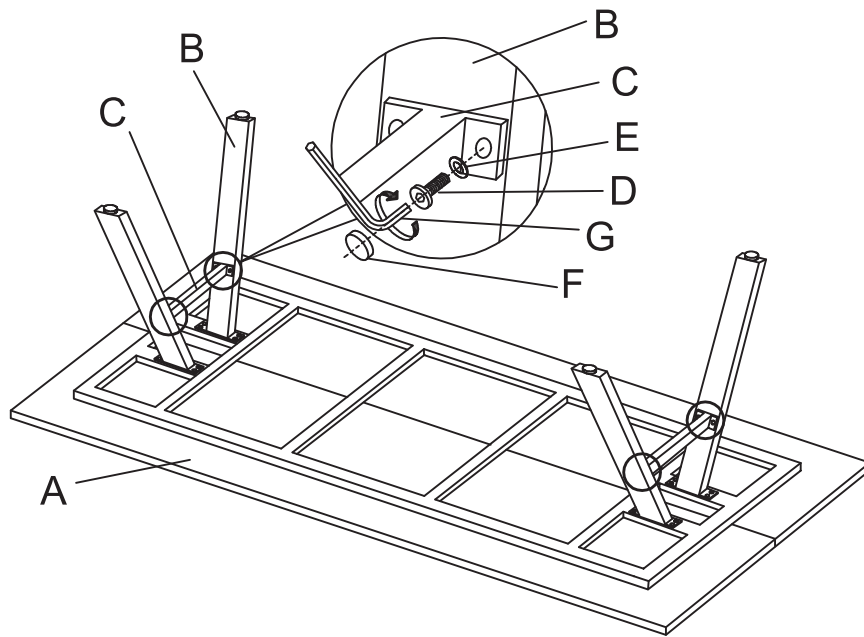

3

