

# NAVIMOW

# *i Series*

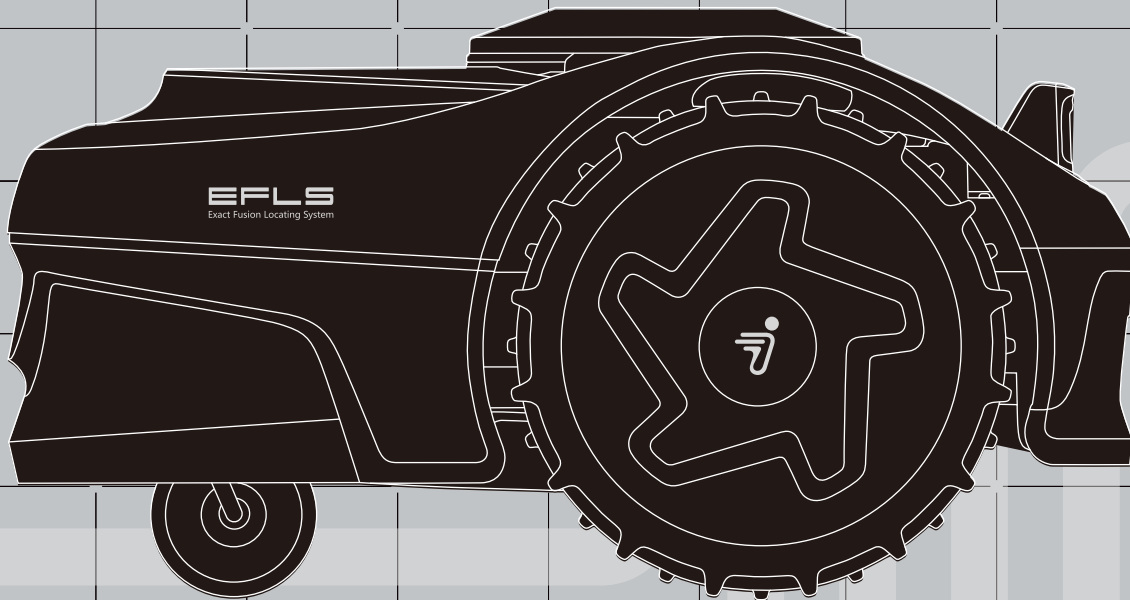

# *User Manual*



Choose Life Without Boundaries

# Table of Contents

1. Overview	3
1.1 Introduction	3
1.2 How EFLS 2.0 works	4
1.3 Safety Warnings	6
1.4 Symbols and Decals	7
1.5 What's in the Box?	9
1.6 Accessories (sold separately)	10
2. Setup and Mapping	15
2.1 Before You Start	15
2.2 Activate the Mower	16
2.3 Find a Proper Location	20
2.4 Install the Antenna	23
2.5 Check the GPS Signal	27
2.6 Map out the Work Area	28
3. Daily Use	28
3.1 Mow	30
3.2 Light Cue	31
3.3 Mow	33
3.4 Navimow app	35
3.5 Notifications	36
3.6 Settings (Mower)	40
3.7 Settings (app)	41
3.8 IoT	42
3.9 Obstacle Avoidance	44
3.10 Accessories (optional)	47
4. Maintenance	47
4.1 Cleaning	48
4.2 Replace Blades	49
4.3 Transportation	49
4.4 Battery	51
4.5 Power Supply	51
4.6 Storage	51
4.7 Recycling and End-of-life Disposal	52
4.8 Others	53
5. FAQ & Troubleshooting	57
6. Important Information	57
6.1 Trademark and Legal Statement	58
6.2 EC DECLARATION OF CONFORMITY	59
6.3 UKCA DECLARATION OF CONFORMITY	60
6.4 Certifications	62
6.5 Limited Warranty	65
6.6 About the Manual	65
6.7 Contact Us	

# Welcome

---

***Thank you for choosing Navimow i Series!***

With Exact Fusion Locating System 2.0 (EFLS 2.0) and superb traversing capabilities, Navimow can handle lawns of all types. No perimeter wires are needed and it's super easy to use, thanks to smart app connectivity and the intuitive control panel. Collection of grass is not necessary because the fine grass clippings serve as a natural fertilizer. Enjoy the fun of carefree mowing and a perfectly maintained lawn.

# 1. Overview

## 1.1 Introduction

### Navimow i Series

Segway Navimow pioneered the development of residential robotic lawnmowers without boundary wires and launched Navimow the H Series as its first-generation product in 2022.

The Navimow i Series is a brand new series of robotic lawnmowers designed for compact lawns. For lawns with a size of less than 1000 m<sup>2</sup> (1/4 acre), the Navimow i Series is your first choice for lawn maintenance.

Navimow has an advanced robotic mowing system that uses a virtual boundary, eliminating the need for complicated perimeter wiring. Easy to operate and manage, Navimow i Series gives you more free time to do the things you love and an effortlessly impeccable lawn with every use. The Navimow system includes a robotic lawn mower, a charging station, and a GNSS (Global Navigation Satellite System) antenna, and the Navimow app. The robotic lawnmower and GNSS antenna simultaneously receive positioning signals from satellites to locate the mower and the work area. The charging station charges the mower and transmits the satellite positioning signal received by the GNSS antenna to the mower to improve the positioning accuracy of the mower. The app is used to remote control the mower and monitor real-time status.

### Mower

The robotic lawnmower is powered by a rechargeable lithium-ion battery pack. Using the Navimow app on your phone, you can define the boundaries of a work area. The mower will then automatically cut the grass within the boundaries. The mowing paths are calculated by the algorithm according to the shape of the work area to achieve the highest mowing efficiency. If the battery runs low before finishing a mowing task, it will automatically go back to its charging station to recharge. When charged to 95% of battery level, it will pick up where it left off to complete the task.

3

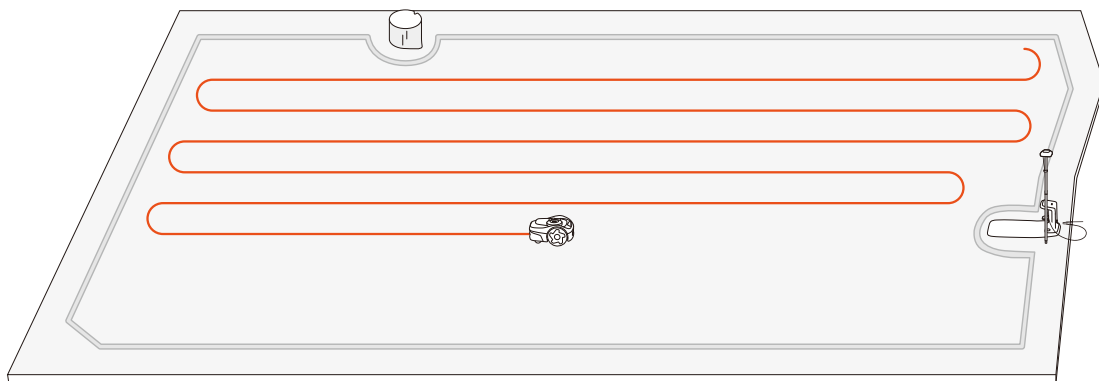

### Navimow App

The Navimow app is an important part of the Navimow system. You can follow the interactive guidance shown via the app to complete the system installation and set up the work area. You can also use the app to adjust the settings of the mower, customize the work area, view the work status of the mower, control the mower remotely, etc. You can also get the latest and most comprehensive official Help and Support content through the app.

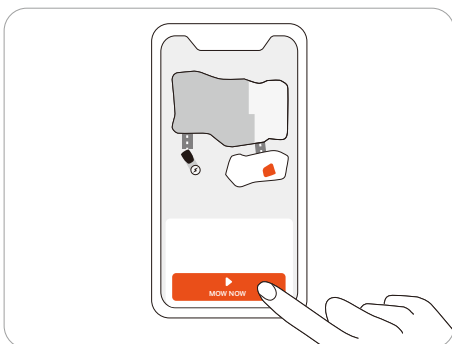

## 1.2 How EFLS 2.0 Works

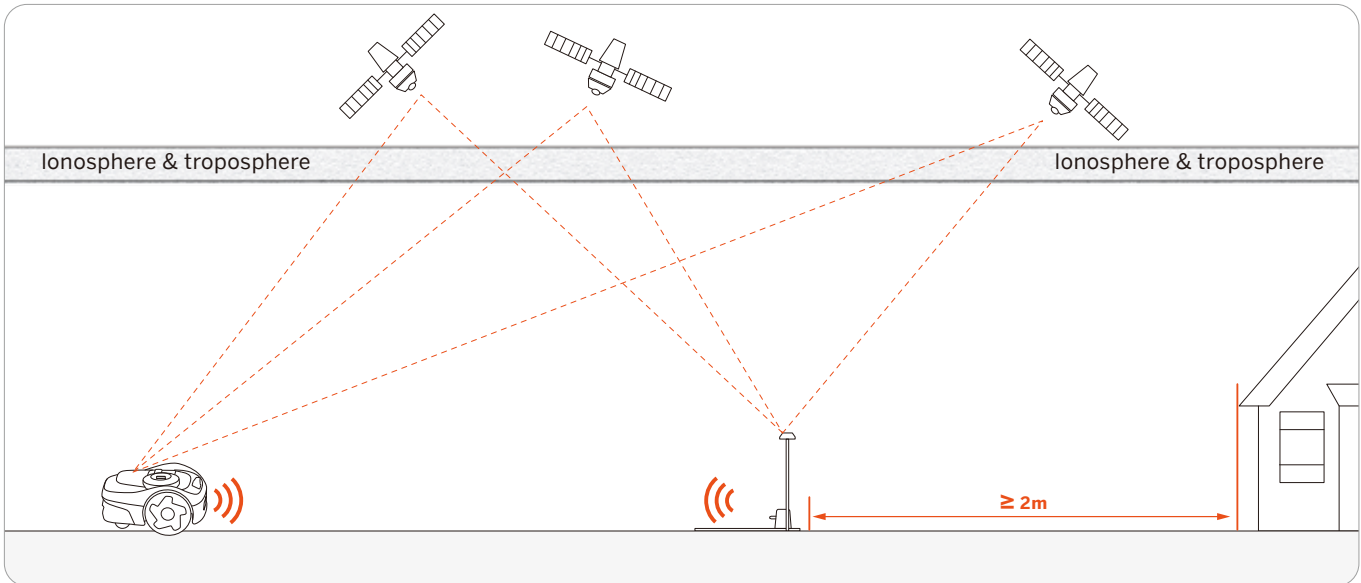

EFLS (Exact Fusion Locating System) is Navimow's unique high-precision localization technology. Based on satellite positioning, EFLS technology integrates various sensor data to improve positioning accuracy and fault tolerance through algorithm fusion.

The mower can locate itself through satellite signals, which can also be picked up by the antenna. By comparing the satellite signals from the antenna and the mower, errors in the transmission of the signal (such as the offset of the satellite signal as it travels through the ionosphere) can be minimized, improving satellite positioning accuracy to the centimeter level.

In addition, the data collected by the gyroscope, accelerometer, magnetic compass, and odometer sensors can also be integrated into this system through Navimow's data fusion algorithms, further improving the applicability of Navimow to various environments.

EFLS 2.0, combined with VSLAM (visual simultaneous localization and mapping) technology, is another step toward a more accurate positioning. In a yard where bushes and tall trees may be blocking the GPS signal, or where the antenna is installed close to houses, positioning can be inaccurate. With the help of from EFLS 2.0, you will get a precise work area in these complex outdoor environments without laying boundary wires, and the mowing paths are optimized through algorithms in the work area to achieve planned mowing results and maximize the mower's work efficiency.

By integrating data collected from the camera sensor, EFLS 2.0 can reduce errors and inaccuracies caused by poor GPS signal. During mapping, the lawnmower uses its camera to capture key features of the environment like houses and trees. It builds a visual map from these features and stores them digitally. Later, when it reaches a familiar location, the lawnmower can locate itself by comparing current images to features stored in the map. Unlike satellite signals which can be blocked, a visual map works anywhere. As it cuts more, the lawnmower adds more visual information to the map. This increases coverage and allows it to update the map if the environment changes. Over time, an up-to-date visual map improves the lawnmower's ability to locate itself. For instructions on mapping and using EFLS 2.0 tools to improve positioning accuracies, see 2.6 Map out the Work Area.

# 1.3 Safety Warnings

## IMPORTANT

### READ CAREFULLY BEFORE USE

### KEEP FOR FUTURE REFERENCE

- 1) Be sure to install and operate the Navimow (referred to as the mower in this manual) and the charging station according to the instructions. Go to [navimow.segway.com](http://navimow.segway.com) or the Help and Support section via the app for the complete User Manual and the latest user materials.
- 2) The product is intended to be used for domestic lawn mowing. Using the mower for purposes other than mowing can bring serious injury. To avoid risks of injury, please read and understand all the warnings and cautions. Please understand that you can reduce the risk by following the instructions and warnings in this manual, but you cannot eliminate all the risks. The operator or user is responsible for accidents or hazards occurring to other people on their property.
- 3) Navimow has many built-in safety sensors; however, safety risks still exist. Set a mowing time when there are no people or pets on the lawn. Inform the neighbors about the risks of accidents or hazards. When using the mower on a public lawn, or when your lawn is open to your neighbors or street, protect or fence the lawn, or put up a warning sign around the working area that says: WARNING! Automatic lawnmower! Keep away from the machine! Supervise children!
- 4) DO NOT attempt to repair or make manual adjustments to the mower by yourself. Any unauthorized changes to the mower could disrupt its operations, potentially causing serious injury and/or damage, and may also void the Limited Warranty. Use only Navimow approved parts and accessories.
- 5) The manufacturer recommends the user to be 18–70 years old. Be sure to get the necessary training before operating the machine.

### WARNING

Never allow children, persons with reduced physical, sensory or mental capabilities or lack of experience and knowledge or people unfamiliar with these instructions to use the machine. Local regulations may restrict the age of the operator.

#### Before Mowing:

- Regularly check that all parts of the mower can function normally.
- For the best mowing results, it is recommended to mow in dry weather. Mowing in the rain can make the grass stick on the product and the mower may slip. DO NOT mow in bad weather, such as heavy rain, thunderstorm or snow.
- Periodically inspect the area where the machine is to be used and remove all stones, sticks, wires, bones, and other foreign objects. The Limited Warranty does not cover damages caused by objects left on the lawn.
- To avoid possible damage, keep the operating mower at least 1 m (3 feet) away from sprinkler heads. The mower and the sprinkler should NOT work simultaneously. Time the mower so that it works at a different time from the sprinkler.
- NEVER allow children to touch the power supply unit, charging station, blades, the battery compartment, or any parts with gaps such as the wheels.

### WARNING

Never operate the machine and/or its peripherals with defective guards or shields, or if the cord is damaged or worn.

#### When Mowing:

- Keep away from the rotating blades! DO NOT put hands or feet under or near the rotating blades.
- Watch out for throwing objects! Keep a safe distance from the mower when operating.
- DO NOT leave the machine to operate unattended if you know that there are pets, children or people in the vicinity.
- DO NOT overreach. Keep your balance at all times and always be sure of the footing on slopes. Walk, never run while operating the machine or its peripherals.

### WARNING

- DO NOT allow children to be in the vicinity or play with the machine when it is operating.
- DO NOT lift the mower in operation. DO NOT ride on the mower.
- DO NOT mow on areas with slopes steeper than the maximum incline inside the working area (30%), as well as the boundary (10%).
- If the mower makes an abnormal sound or signals an alarm, press the STOP button immediately.
- If there are abnormal vibrations, turn off the mower, place it on level ground for about 30 seconds and then restart. If the issue persists, contact authorized after-sales service.
- DO NOT touch moving hazardous parts before they have come to a complete stop.

#### Safe Usage:

- DO NOT operate or charge the mower outside the temperature limits: 0–40°C (32–104°F), because low/high temperatures can decrease mower performance and even lead to accidents.
- DO NOT place anything on the mower or the charging station.

- It is recommended to conduct regular maintenance of the mower (See Maintenance in the User Manual) by an adult.
- Regularly check the warning devices to ensure they are effective. These devices include the speaker, the LED light on the charging station, and the ambient light on the mower.
- Before charging, please read How to Charge in User Manual. Improper use may cause electric shock, overheating, or leakage of corrosive liquid.
- Use only the original battery pack or that of the same model as specified by Navimow. Each mower contains one battery pack. Depending on the specific mower model, the rated capacity of the battery is 2.55 Ah and 5.1 Ah. Contact after-sales service and have a professional technician to replace the battery pack.
- Do not use non-rechargeable batteries. For the purposes of recharging the battery, only use the detachable supply unit provided with this appliance. For the European Union and Norway: NBW32D002D5N-EU; For the United Kingdom: NBW32D002D5N-UK; For Switzerland: NBW32D002D5N-CH For the United States and Canada: NBW32D002D5N-US. For Australia and New Zealand: NBW32D002D5N-AU.
- DO NOT dismantle or puncture the battery casing. Keep away from metal objects to prevent short circuit. Keep away from fire, heat and direct sunlight.
- For information about battery and electrical waste, please contact your household waste disposal service, your local or regional waste management office, or your point-of-sale.
- When replacing the blades, please be careful and wear protective gloves as the blades may cause damage.
- If the cord on the power supply or the extension cable becomes damaged or entangled during use, disconnect the power supply from the power socket and then untangle. To avoid a hazard, pull the body of the plug rather than the cord when separating the power supply from the power socket. Contact after-sales service and have a professional technician to repair or replace the cord.

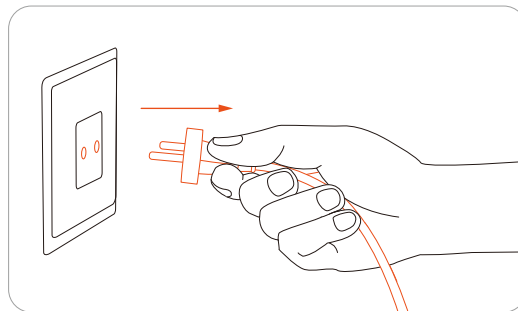

# 1.4 Symbols and Decals

Please study the symbols on the product and labels carefully and understand their meaning:



**⚠ WARNING-Read instruction manual before operating the machine.**



**⚠ WARNING-Do not touch rotating blade.**



**⚠ WARNING-Keep a safe distance from the machine when operating.**



**⚠ WARNING-Do not ride on the machine.**



**⚠ WARNING-Operate the disabling device before working on or lifting the machine\*.**  
 \*The disabling device hereby refers to the PIN code. Make sure the mower is locked by the PIN code before lifting or operating.



**⚠ WARNING-It is not permitted to dispose of this product as normal household waste. Ensure that the product is recycled in accordance with local legal requirements.**



This product conforms to the applicable EC Directives.



This product conforms to the regulations of Restriction of Hazardous Substances.



Before charging, read the instructions.



Class II appliance



Polarity of the charging port



Level VI efficiency



SMPS incorporating a short-circuit-proof safety isolating transformer (inherently or non-inherently)

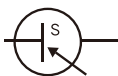

SMPS (Switch mode power supply unit)



Protected from total dust ingress and from high-pressure water jets from any direction



The maximum altitude of use is 5000m



Direct current

ta: 40°C

The maximum temperature of use is 40°C



Class III appliance



Alternating current



# 1.5 What's in the Box?

If there are missing or defective parts, please contact after-sales service. We recommend retaining the package materials for future transportation and shipping.

- Navimow i Series

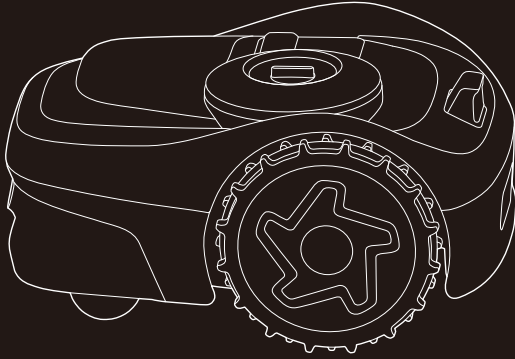

i 105

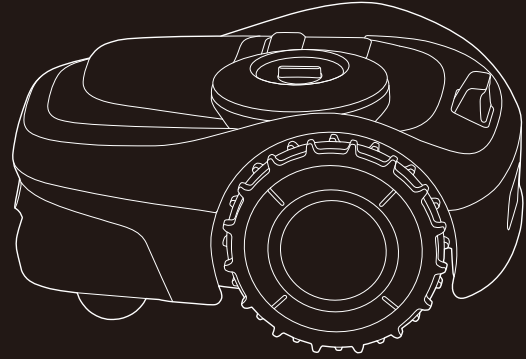

i 108 / i 110

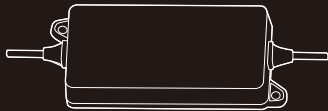

Power supply

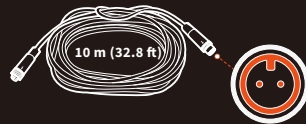

Extension cable for the power supply



Pegs to secure the extension cable

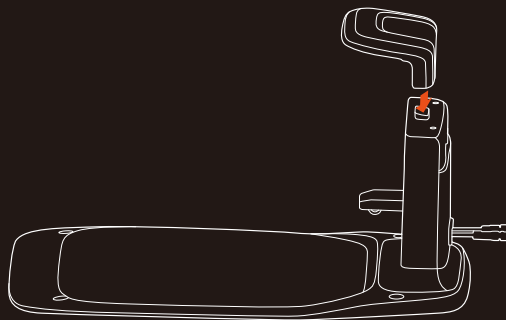

Charging station and the installation kit

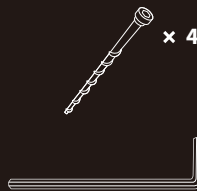

x 4



GNSS antenna



x 4

Silicone pegs for marking the charging station

## ⚠ WARNING

Sharp edges. Do not point at people.

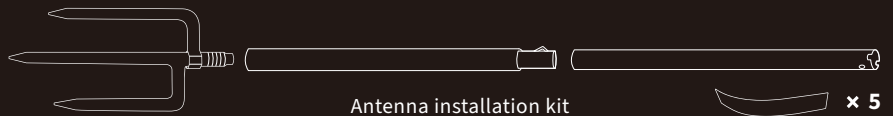

Antenna installation kit

x 5

- User materials

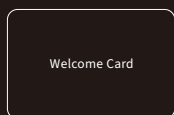

Welcome Card

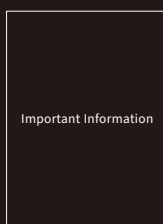

Important Information

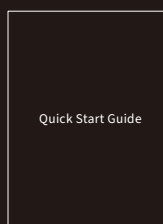

Quick Start Guide

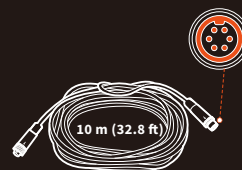

Extension cable for antenna



Spare blades and bolts

# 1.6 Parts and Functions

## Mower

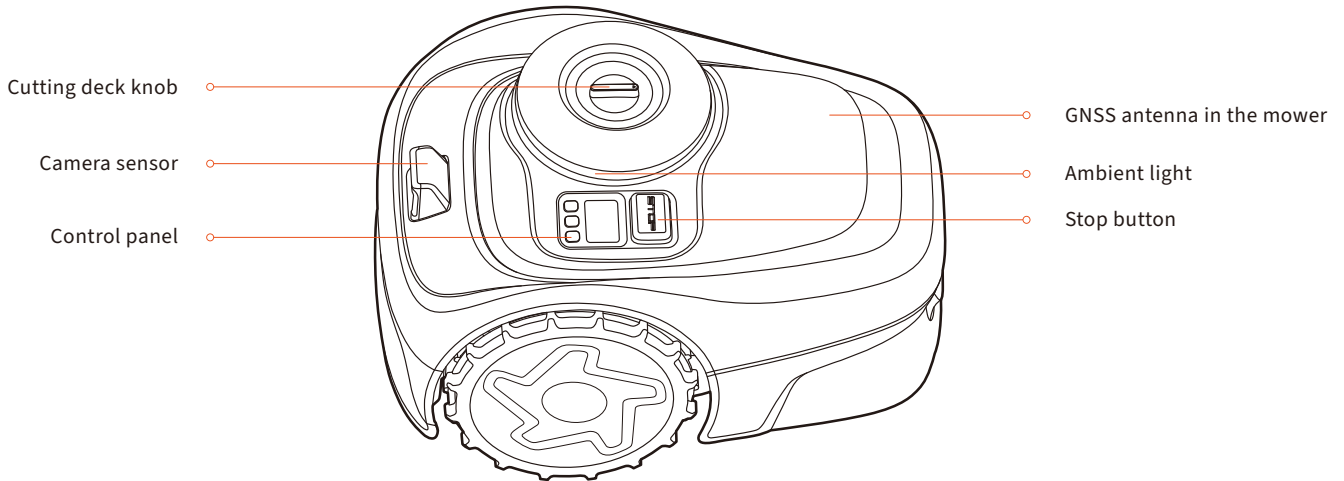

- Control panel: The buttons on the control panel can be used for the basic operations of the mower. The digital numbers on the dashboard display shows mowing progress, battery level, and mower status.
- GNSS antenna inside the mower: In addition to the GNSS antenna connected to the charging station, there is also a GNSS antenna inside the mower to improve positioning accuracy. See 1.2 How the EFLS Works.
- Cutting deck knob: Adjusts the cutting height by turning the knob so the arrow points at a desired number.
- Camera sensor: Detects non-grass objects to avoid bumping into them. EFLS 2.0 uses the camera to capture key visual features of the lawn.
- Stop button: Stops the mower and the blades immediately. When the mower encounters a fault and displays a 4-digit error code, press the STOP button to clear the error code and try to fix the fault.
- Ambient light: Navimow will have specific lighting effects to remind you to pay attention to the state of the mower.





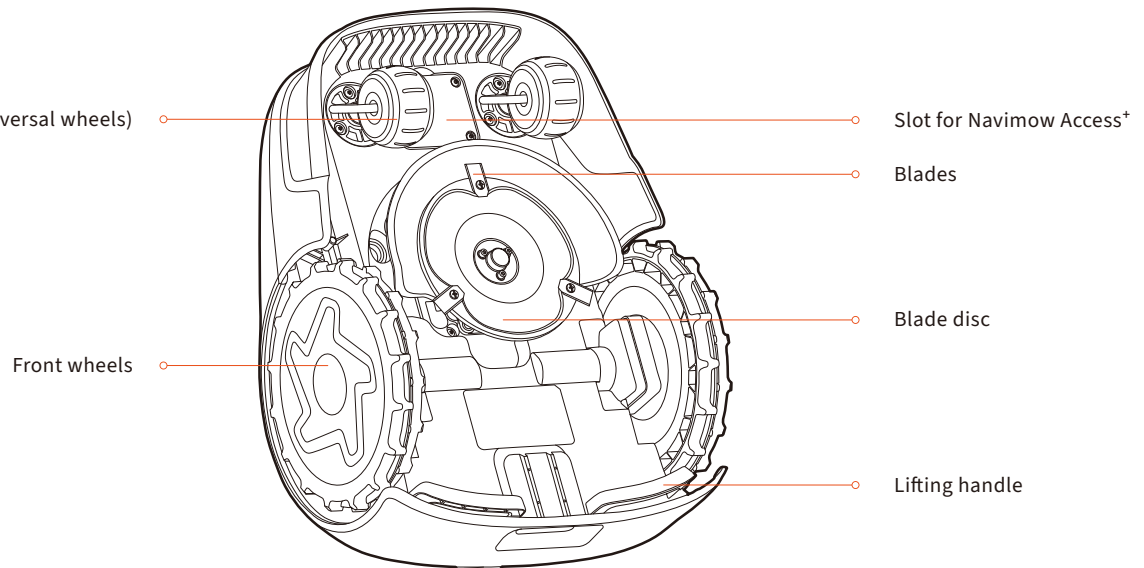





Color	Mower status
Pulsing blue	Mowing
Solid blue	Mapping/Ready to work
Pulsing green	Charging
Solid green	Fully charged
Pulsing yellow	Poor GPS signal
Solid red	Pause/Lifted/Tilted/Flipped over
Pulsing white	OTA updates/Ready for pairing
Flashing white	Blades are rotating

When Navimow works at night, you can adjust the nighttime brightness of the lights on the charging station and the mower. Go to Settings > MOWER > Light setting to customize the settings.

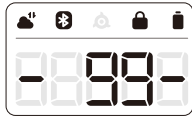

- **Blades:** The blades can rotate freely after being attached to the blade disc. When mowing, the spinning blade disc will generate centrifugal force to keep the blades pointing outside so that the blades can cut grass. When hitting an obstacle, the blade will turn inside. See 4.2 Replace Blades for instructions on replacement.
- **Blade disc:** You can change the cutting height by adjusting the height of the blade disc. This can be done by turning the cutting deck knob on the mower.
- **Slot for Navimow Access+:** Place to install Navimow Access+
- **Lifting handle:** Helps you to lift the mower when necessary.

## Display

Icon with light on	Meaning	
<b>Battery level</b>	The color indicates the battery level: 50%–100% solid green  , 20%–49% solid yellow  , 5%–19% solid red  , less than 5% red flashing. When the battery level low, the mower will return to the station and charge.	
<b>PIN code lock</b>	Mower locked. Please enter the PIN code to unlock, otherwise the mower won't be able to work	
<b>Network connection</b>	Connected to internet via Wi-Fi or cellular network.	
<b>Bluetooth</b>	Bluetooth connected.	
<b>Blade indicator</b>	Blade disc is rotating. Please stay away.	
<b>Dashboard display</b>	Mapping	
	Mowing progress	
	Battery level	
	The mower is stopped	
	E and a four-digit error code	
	The mower is lifted	
	Ongoing OTA updates	

## Control

Basic operation	Instruction
Power on	Press OK.
Power off	Press and hold OK for 4s. The mower cannot be turned off when it's in the charging station. When the mower is turned off, you will hear a sound, display on the mower and the ambient light will be off.
Start mowing	Press MOW and then OK.
Stop mower operation	Press STOP.
Send mower to the charging station	Press HOME and then OK.
Restart the mower	Power it off first, then press OK, or push the mower into the charging station.
Lock the mower	Press and hold MOW+HOME for 4s.
Unlock the mower	Press OK for more than 10s
Force to reboot the mower	Enter the PIN code.

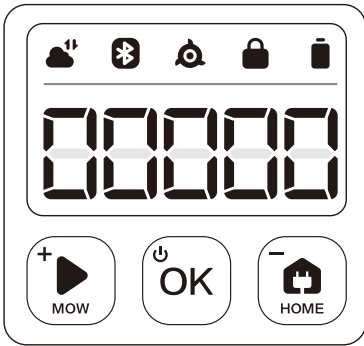

11

### How to enter PIN code

If the mower has been locked, enter the PIN code before operating the mower. The default code is 0000. Press MOW or HOME to change the number and press OK to confirm the code. You can change the PIN code by increasing or decreasing the numbers on the control panel.

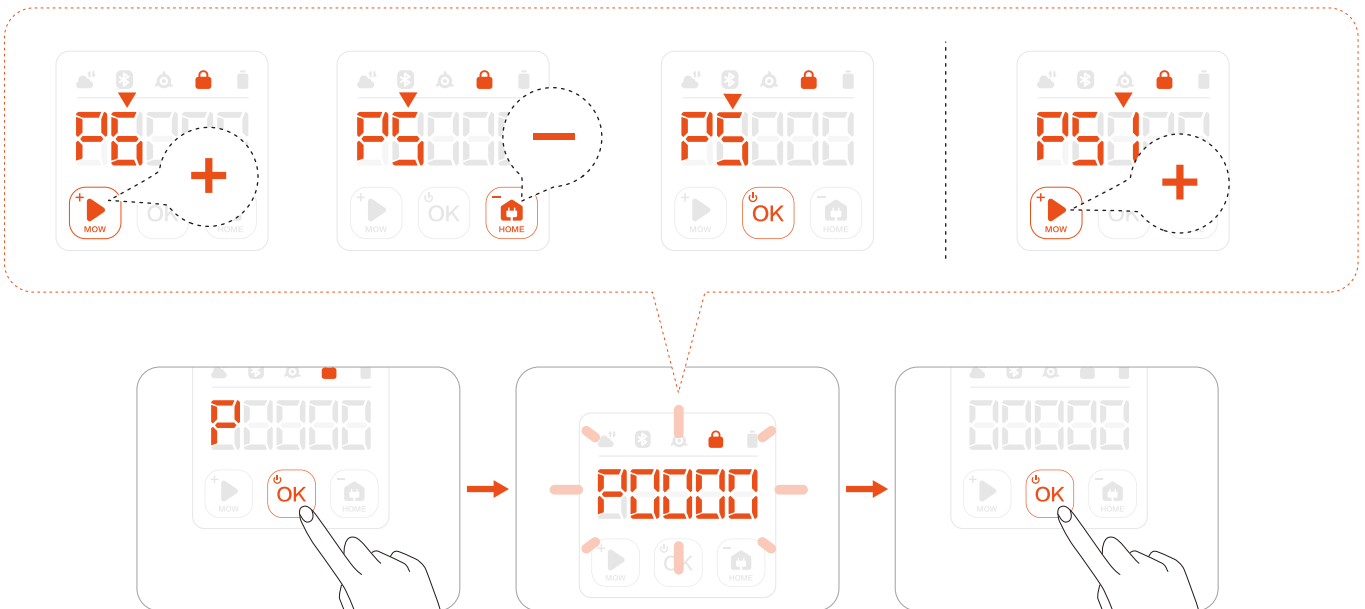

## Charging Station and GNSS Antenna

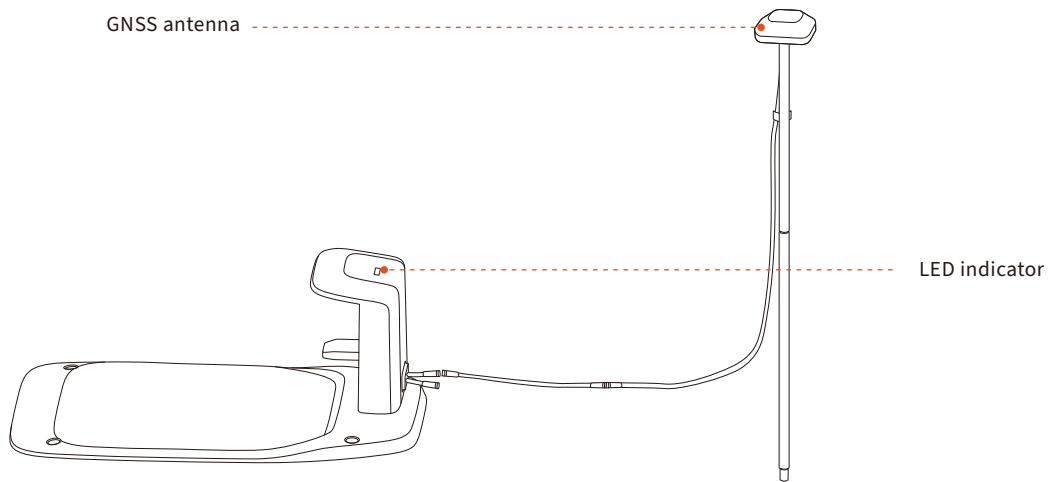

- GNSS antenna: Receives satellite signals to improve the positioning accuracy of the mower.
- LED indicator: Indicates different working states with various colors.

LED indicator	Meaning
Solid blue	The mower is not on the charging station.
Solid green	The mower is on the charging station.
Flashing yellow	No GPS signal/ The charging station is not connected to the antenna.
Solid yellow	Weak GPS signal
Solid red	The mower is disconnected from the charging station. The mower is powered off. The mower is too far away from the charging station.

# 1.7 Specifications

		i105	i108/i110
Basic Information	Model Suffix and Supported Regions:	E: Europe A: Australia and New Zealand N: United States and Canada	
	Product Name	Navimow i Series	
	Brand	Navimow (powered by Segway)	
	Dimensions: Length x Width x Height	545 x 385 x 285 mm (21.4 x 15.1 x 11.2 in)	
	Net Weight (Battery Included)	10.9 kg (24.03 lbs)	10.9 kg (24.03 lbs)
	Material	Mower frame: PP; cover: ASA	
Mower Parameters	Recommended Mowing Area	i105E, i105A: 500m <sup>2</sup> i105N: 1/8 acre	i108E, i108A: 800m <sup>2</sup> i110N: 1/4 acre
	Typical Mowing Time Per Full Charge <sup>(1)</sup>	About 60 min	About 120 min
	Area Capacity per Hour	i110N: 80-120 m <sup>2</sup> (0.02-0.03 acre) All others: 60-100 m <sup>2</sup> (0.015-0.025 acre)	
	Cutting Width	18 cm (7.1 in)	
	Cutting Height	Europe, Australia, New Zealand: 20-60mm (1.2-2.4 in) United States and Canada: 50-90mm (2-3.6 in)	
	Charging Time	About 90 min	About 180 min
	GNSS Working Mode	GPS, Beidou, Galileo, GLONASS	
Noise Emissions <sup>(2)</sup>	Measured Sound Power Level LWA	58 dB(A)	
	Sound Power Uncertainties KWA	3 dB(A)	
	Sound Pressure Level LpA	50 dB(A)	
	Sound Pressure Uncertainties KpA	3 dB(A)	
Working Conditions	Working Temperature	0-40°C (32-104°F); 10-35°C (50-95°F) recommended	
	Storage Temperature	-20-50°C (-4-122°F); 10-35°C (50-95°F) recommended	
	IP Rating	IP66 for mower body, charging station and power supply	
	Max. Incline Inside Working Area	30%	
	Max. Incline at Boundary	10%	
	Minimum Angle for Cutting Area	90°	
Connectivity	Bluetooth® Frequency Range	2400.0-2483.5 MHz	
	ISM Band Radio Connection	Europe: 865-868 MHz Australia, New Zealand, United States and Canada: 915-918 MHz	
	Wi-Fi/Cellular Network	Wi-Fi 2.4 GHz Europe: LTE-FDD: B1/B3/B5/B7/B8/B20/B28 LTE-TDD: B38/B40/B41 Australia, New Zealand: LTE-FDD: B1/B2/B3/B4/B5/B7/B8/B28/B66 LTE-TDD: B38/B40/B41 United States and Canada: LTE-FDD: B2/B4/B5/B12/B13 LTE-TDD: B14/B66/B71	
Driving Motor	Rated Speed	i110N: 0.5 m/s All others: 0.4 m/s	
	Motor Type	9.6 inch TPU tyre with gear motor	
Blade Motor	Rated Speed	2500/min	
	Motor Type	Brushless motor	
Battery Pack	Battery Type	Lithium-ion battery	
	Nominal Voltage	21.6 V DC	
	Nominal Capacity/Energy	2.55 Ah / 55 Wh	5.1 Ah / 110 Wh
	Battery Management System	Over-heating, short circuit, over-current and over-charge protection	

## 1.8 Accessories (sold separately)

### Antenna Extension Kit

Antenna Extension Kit is for antenna installation on a wall or roof, improving satellite signal.

#### Overview

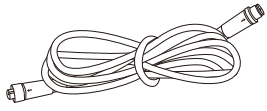

Extension cable 10m x1

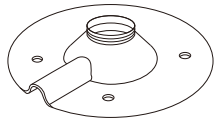

Installation base x1

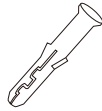

Expansion tube x4



Self-tapping screw x4



Center column x1

#### ⚠ CAUTION:

Whenever the location of the antenna is changed, the existing map cannot be used anymore, please create a new map for your lawn.

#### ⚠ WARNING:

Roof top antennas of any sort should have lightning protection and thunder protection. Proper reinforcements are needed in case of strong winds or storms.

#### How to install

- 1 Affix the center column on the installation base.

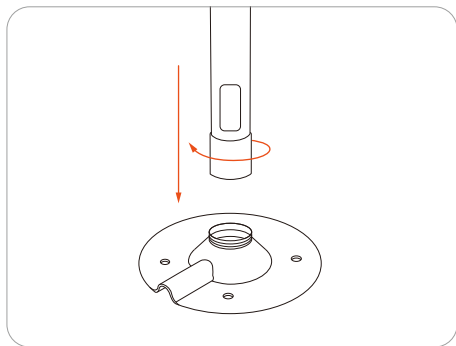

- 2 Install the GNSS antenna.

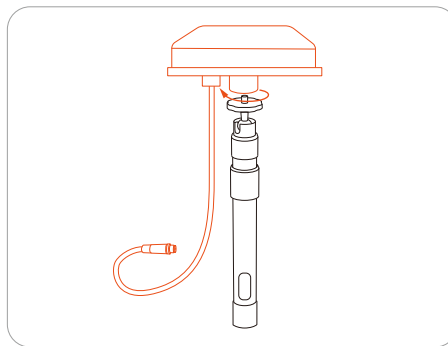

- 3 Connect the extension cable with the charging station. In case the cable is still not long enough, connect another 10m (33 ft) extension cable. The total length of the extension cable can be 30m (98 ft). Insert the power plug into a suitable power outlet.

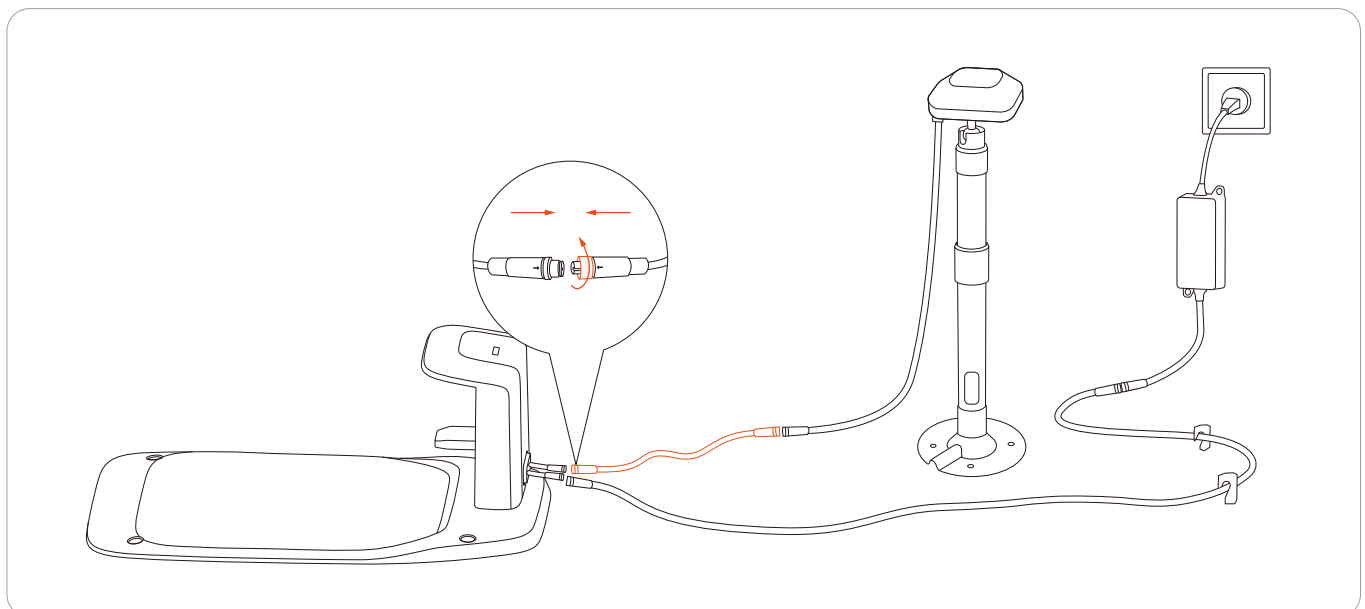

- 4 Hold the GNSS antenna to a place where you want to install it. Make sure that the top surface of the antenna points straight up. When the signal indicator on the antenna becomes solid green or blue, the signal is strong.

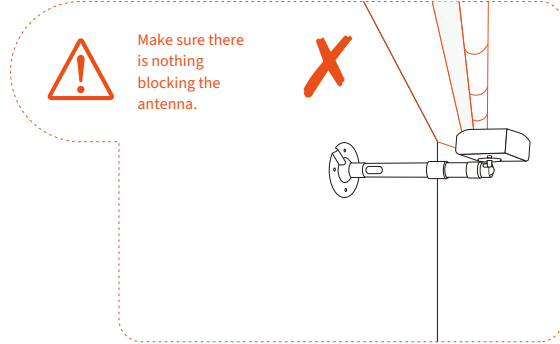
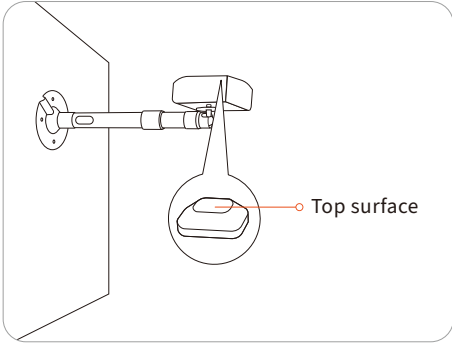

- 5 Secure the installation base.

- For a wooden surface, just secure the base with the self-tapping screws.
- For harder surfaces (like concrete, brick and stone), drill two 8 mm holes, insert the expansion tubes, and then secure the base by tightening the screws.

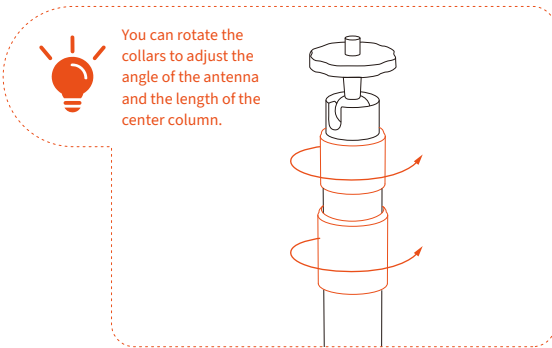

## Antenna Extension Pole

Antenna Extension Pole is used to extend your antenna as to avoid bushes or small trees from blocking GPS signals. You can use 1 or 2 pieces of poles to extend your antenna to 1.5 m (4.9 ft) or 2 m (6.6 ft).

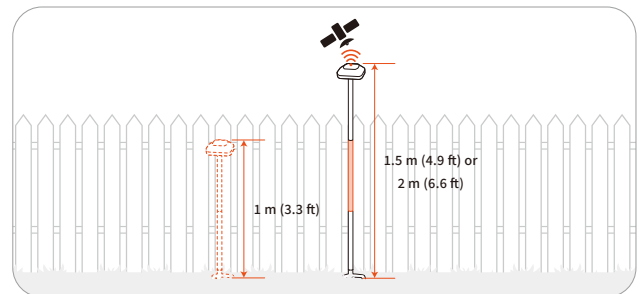
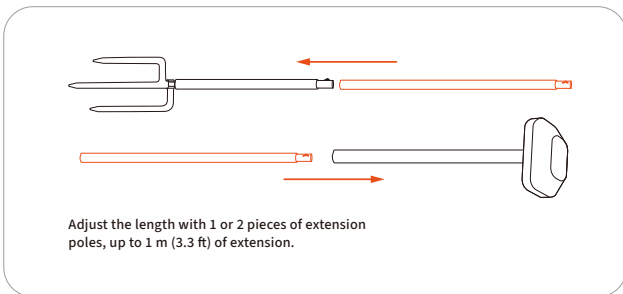

### ⚠ CAUTION:

Not for strong winds or hurricane/tornado wind loads. Reinforce the antenna pole in all cases to prevent displacement or failure in unexpected weather conditions.



## Blade Assembly

### Spare blades and bolts



Blades for regular replacement. For advice and how-to guides for blade replacement, see 4.2 Replace Blades.

## Temporary Fence

Protect areas that you don't want the mower to enter.

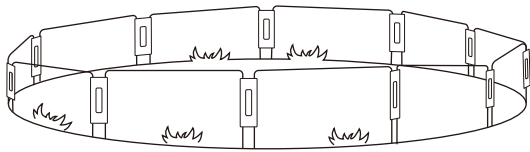

### How to Install

Insert the fencing arches into the ground to form a protective fence. Use the connecting panels to secure the arches.

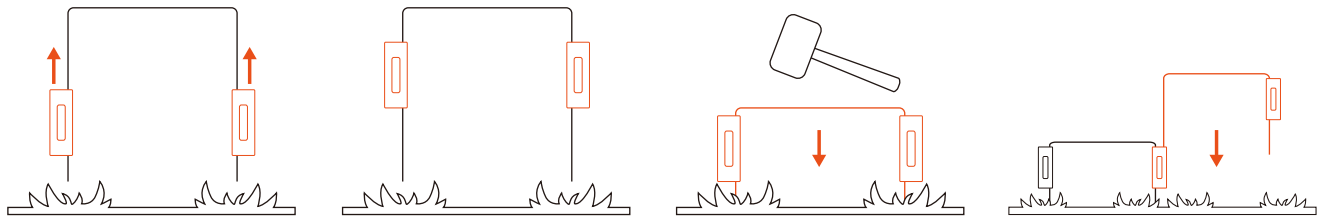

## Navimow Access<sup>+</sup>

Navimow Access<sup>+</sup> is an IoT module used to connect to a 4G network. When the mower is connected to a 4G network, you can enable the Anti-theft to locate your mower in real-time and receive alarms if the mower goes out of the work area.

### How to install and activate

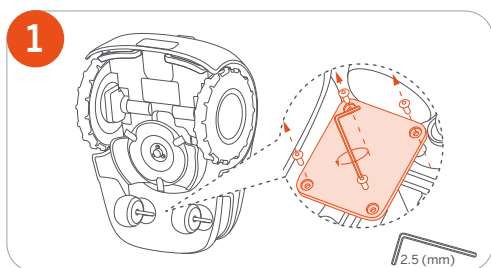

1. Use a 2.5 mm Allen wrench to untighten the 4 screws.

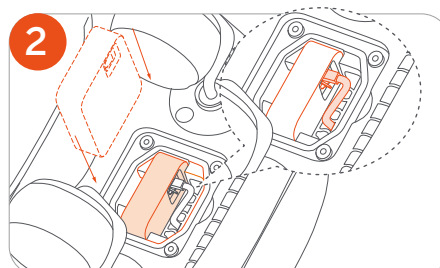

2. Place the Navimow Access<sup>+</sup> inside the mower according to Image 2.

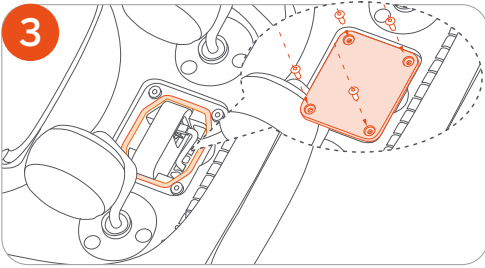

3. Secure the screws back onto the lid.

Note: To prevent liquid or moisture from getting in, make sure the rubber seal strip is in place and the screws are tightened.

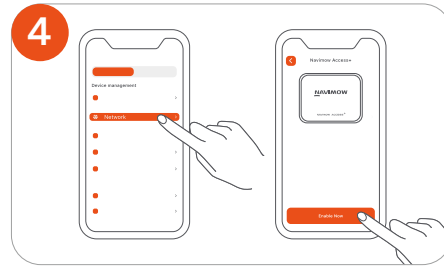

4. Activate the Navimow Access+ from **Settings>MOWER>Device management>Network.**

## Navimow Garage S

Navimow Garage S is fully compatible with the Navimow i Series, as it does not block GPS signals or network connectivity. The garage provides extra protection against sunshine and rain. The flip-up cover enables easy access to the control panel so you can operate the mower on the charging station.

### How to assemble and install

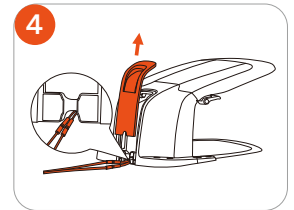
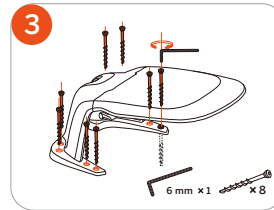
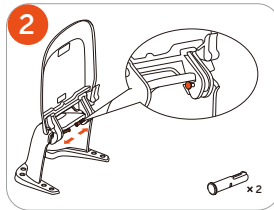
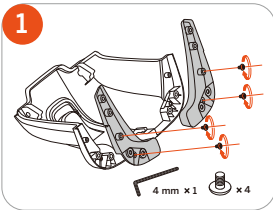

## 2. Installation and Mapping

### 2.1 Before You Start

#### Prepare the app

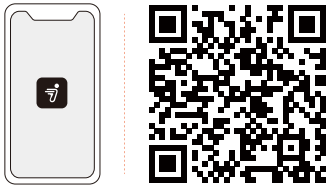

To ensure a successful setup, please scan the QR code to download the Navimow app. Alternatively, go to the Google Play Store (Android) or the Apple App Store (iOS) and search 'Navimow'. After installing the app, please register and log in.

**NOTE:** During use, the app will ask you for Bluetooth, GPS positioning, and Wi-Fi networking accesses when necessary. To ensure normal use, it is recommended that you enable the above accesses. For more information, please refer to our Privacy Policy. Go to [Settings>app>About>Privacy Policy](#).

#### Prepare the lawn

Before using Navimow to start mowing, please cut your lawn to a height of no more than 6 cm (3.6 inches for US and Canada). Remove debris, piles of leaves, toys, wires, stones and other obstacles. Make sure children and pets are off the lawn.

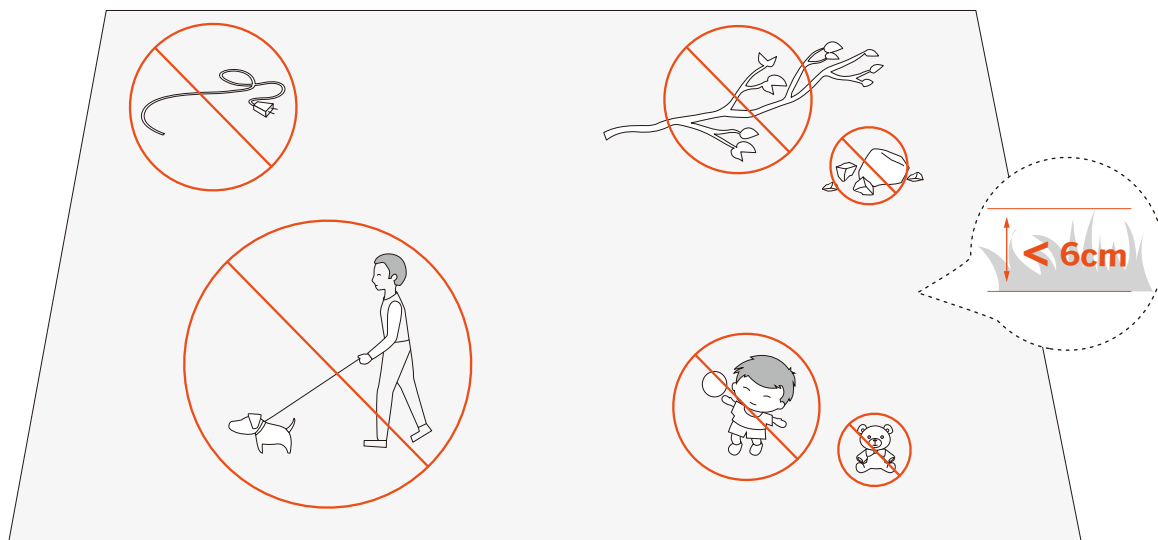

## Charge the mower for the first time

A new mower may have a low battery after a long-time storage. Fully charge the mower before the first use. Place the mower in the charging station. Make sure the charging strip on the mower and the contact strip on the charging station are in good contact.

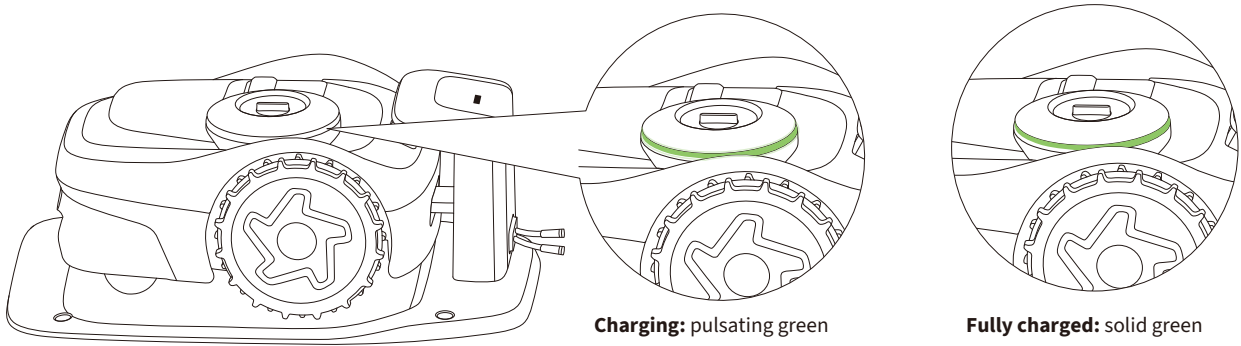
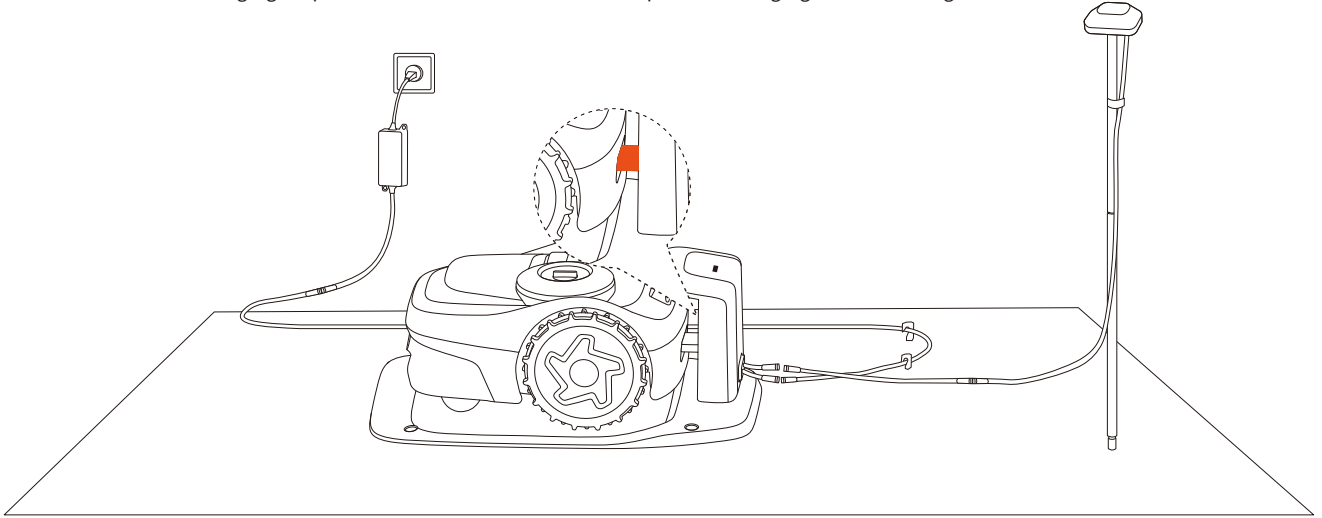

## 2.2 Activate the Mower

1 Press the OK button on the mower to power it on.

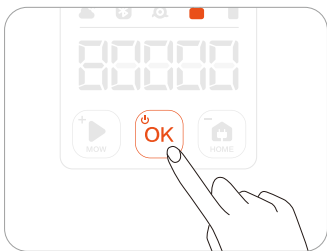

2 Pair up the mower via Bluetooth.

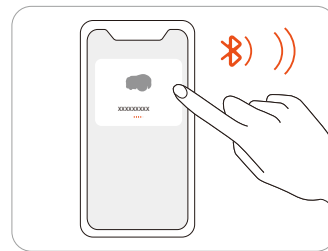

3 Connect to a Wi-Fi or cellular network.



Note: To connect to a cellular network, you need to purchase the 4G module Navimow Access+, an accessory that is sold separately. For more information, see 1.8 Accessories.

## 2.3 Find Locations

The basic principles for placing the antenna and the charging station are:

1. Remain a certain distance away (greater than 2 m/6.6 ft) from houses, trees and walls.
2. Place the charging station and antenna in an open space with nothing blocking the signal (for example, the tree canopy or the sunshade umbrella).
3. Place the charging station and the antenna a flat non-hardened ground and keep them upright. DO NOT install them on a slope.

### 2.3.1 Antenna Location

Choosing the antenna location is one of the most important steps in setting up your mower. The antenna needs to be installed in a place that allows it to share as many Co-visible Satellites as possible with the mower from any point on your lawn. Otherwise, the mower will struggle to locate itself accurately during mowing. For more information about the Co-visible Satellites, see 2.3.3 Verify Locations using Satellite Signal Analyzer.

The guidelines for finding a proper location are:

- Choose an open area with no walls blocking views in any direction if possible. Make sure the sky directly above the antenna is not obstructed by trees or roofs.
- If full openness on all sides can't be achieved, at least keep the southern sky clear when in the Northern Hemisphere, or the northern sky when in the Southern Hemisphere. (If possible, try to keep the east and west sides clear of obstacles.)

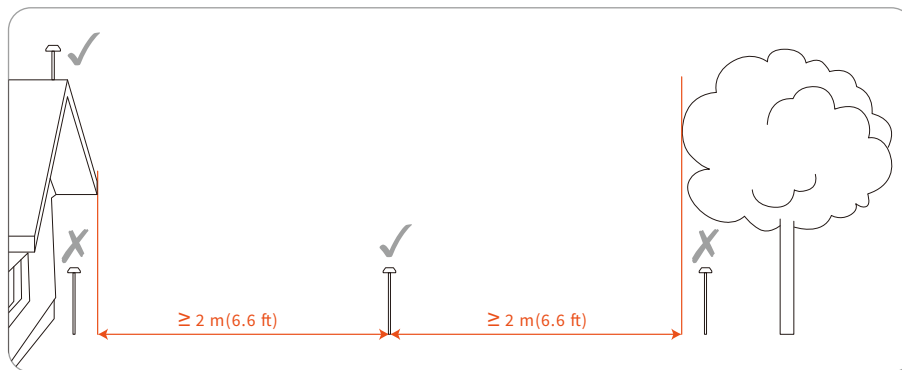

If the signal reception is still poor, consider using one of the Navimow official accessories (see 1.8 Accessories):

- the Antenna Extension Pole to lift up the antenna
- the Antenna Extension Kit to mount the antenna on a wall or roof for complex yards

### 2.3.2 Charging Station Location

The charging station determines the location where the mower will stay for charging. If the charging station is not properly located, the mower may fail to start mowing due to weak GPS signal. You can locate the charging station close to the antenna, or ensure there are enough number of Co-visible Satellites between the antenna and the mower.

Install the charging station on a soft and flat surface. When placed outside, the charging station and the lawn should be kept at the same level.

- Make sure the sky view on the same side with the antenna is unobstructed
- Install it in an open space with nothing blocking the signal within a radius of 2 m (6.6 ft)
- Do not cover the charging station (the Navimow official Garage does not block signals)
- Stay away from sprinkler heads, fountains or other outdoor water systems
- Stay away from substations, generators, water pump stations and air conditioners

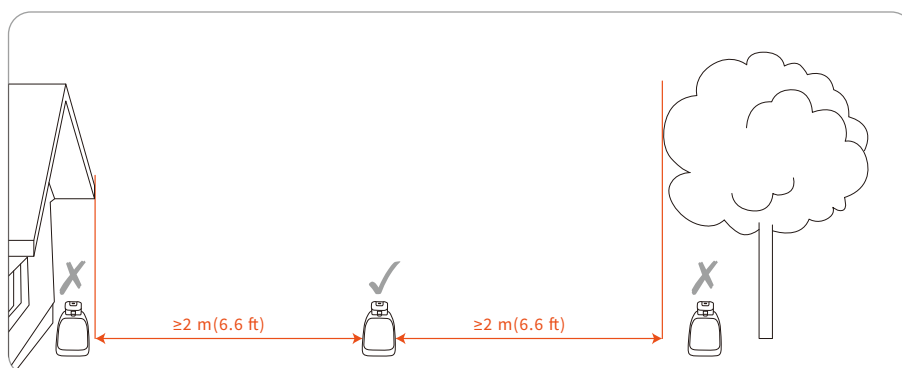

## 2.3.3 Verify Locations using Satellite Signal Analyzer

When both the mower and the antenna are connected to the same satellite, it's called a 'Co-visible Satellite'. For accurate positioning of the mower, it requires at least 5 Co-visible Satellites. Having more Co-visible Satellites means the positioning is better.

The Satellite Signal Analyzer helps you to check if your antenna and the charging station are installed at a proper location. Go to Settings>MOWER>EFLS 2.0>Satellite Signal Analyzer.

If the result says there are enough Co-visible Satellites, it means that the location of the charging station and the antenna are OK. If the result says there aren't enough Co-visible Satellites, it means you need to move the charging station and the antenna to different places. After that, check the number of Co-visible Satellites again.

Note: It is only available when the mower is in 'Charging' or 'Standby' status.

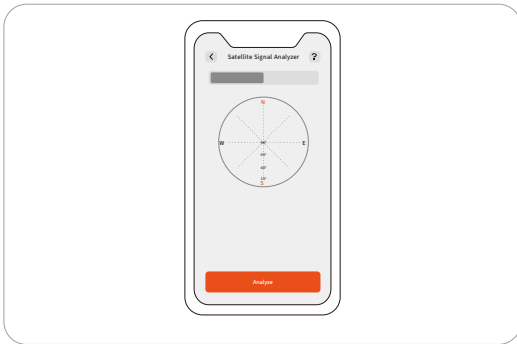

Please choose the location carefully. Once the map is saved, if the location of the charging station or GNSS antenna is changed, you need to create a new map.

## 2.4 Install the GNSS Antenna and the Charging Station

### 2.4.1 Install the GNSS antenna

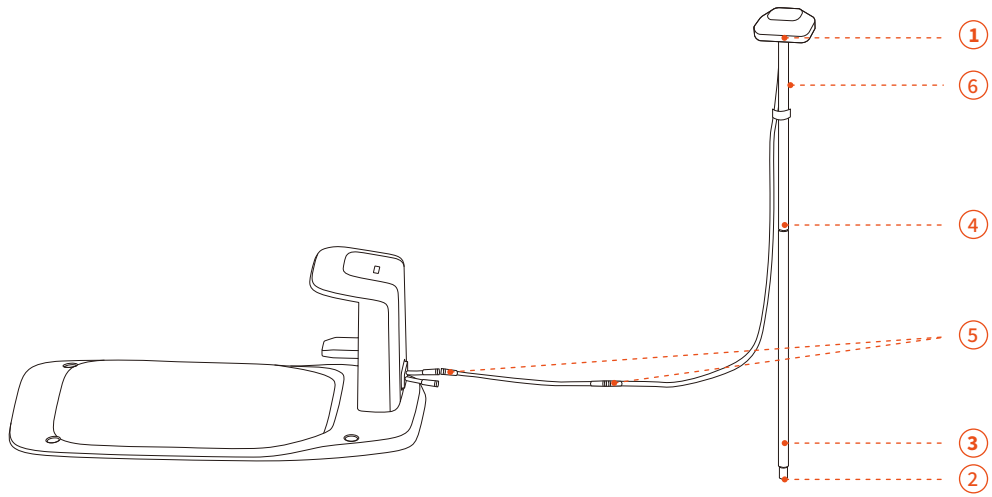

- 1 Fix the GNSS antenna on the tube.

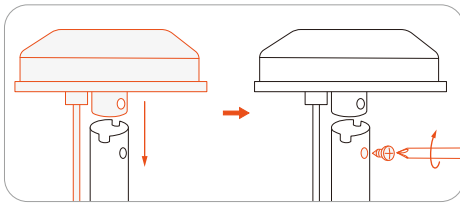

- 2 Unfold the base fork and insert it into the ground.

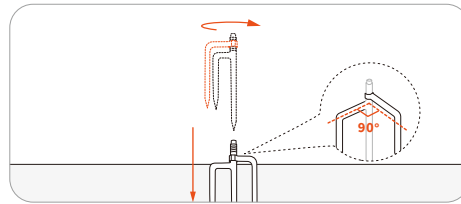

To make sure that the antenna can be stably connected to the charging station once the installation is completed, please fully insert the base fork into the ground.

- 3 Rotate the other extension tube onto the base fork.

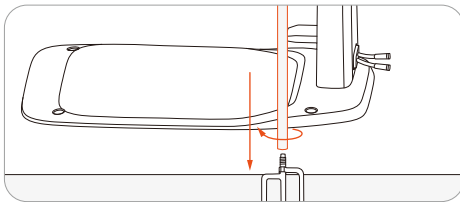

- 4 Slide in the tube with the antenna.

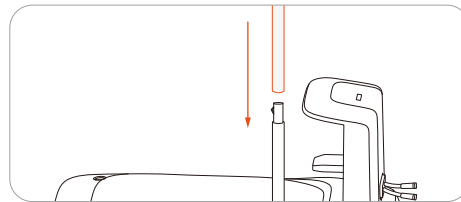

- 5 Connect the GNSS antenna to the charging station. If the cable isn't long enough, you can buy extra antenna extension cables and use 3 cables at most to extend the total length up to 30 m (98.4 ft).

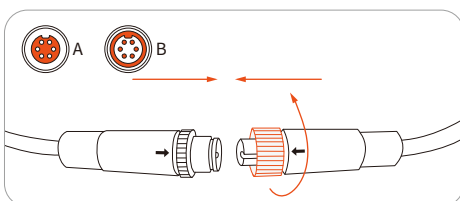

Secure the nuts tightly to prevent water from entering them.

- 6 Secure the antenna cable on the pole with the supplied hook and loop tape.

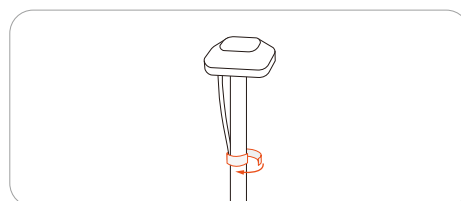

To ensure satellite signal, DO NOT put anything on the antenna.

## 2.4.2 Install the Charging Station

1. Connect the power supply cable to the power supply adapter.

Align the notch on the power supply cable (A) with the base on the power supply adapter (B).

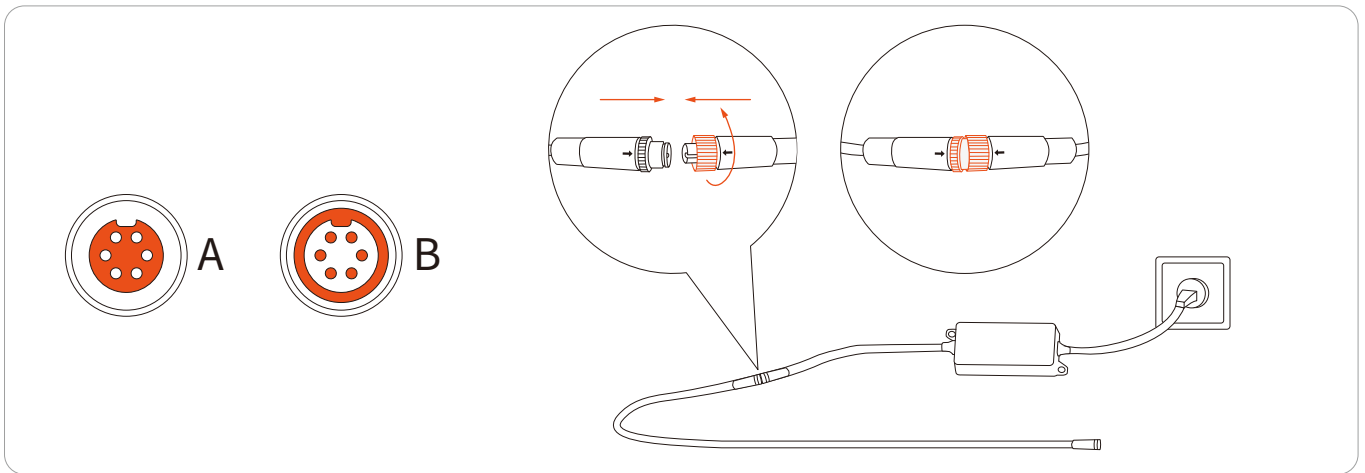

2. Connect the power supply cable to the power interface. Turn the nuts until they are locked into each other.

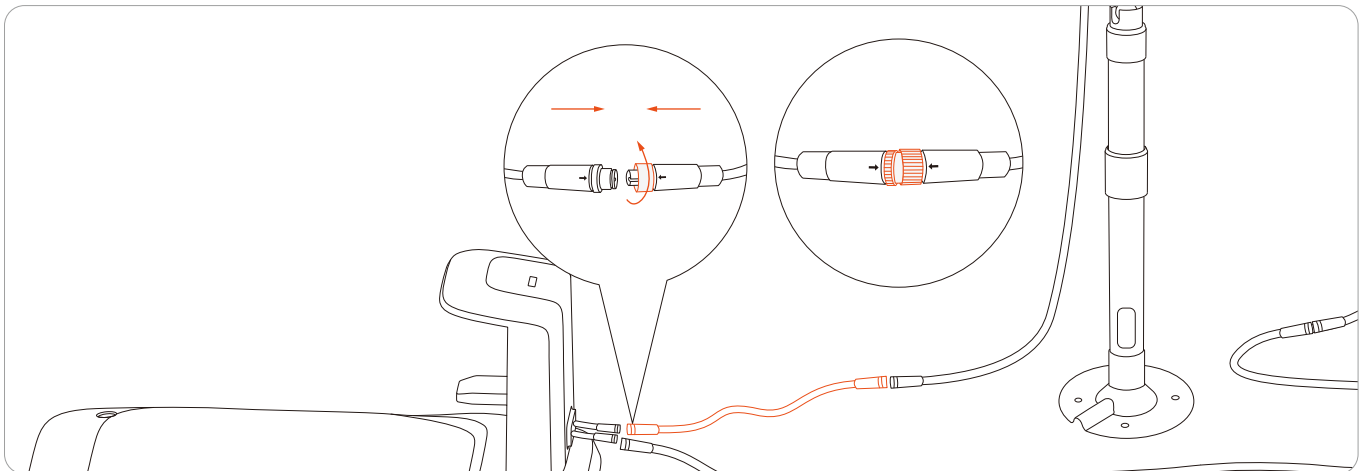

3. Insert the power plug into a suitable power socket.

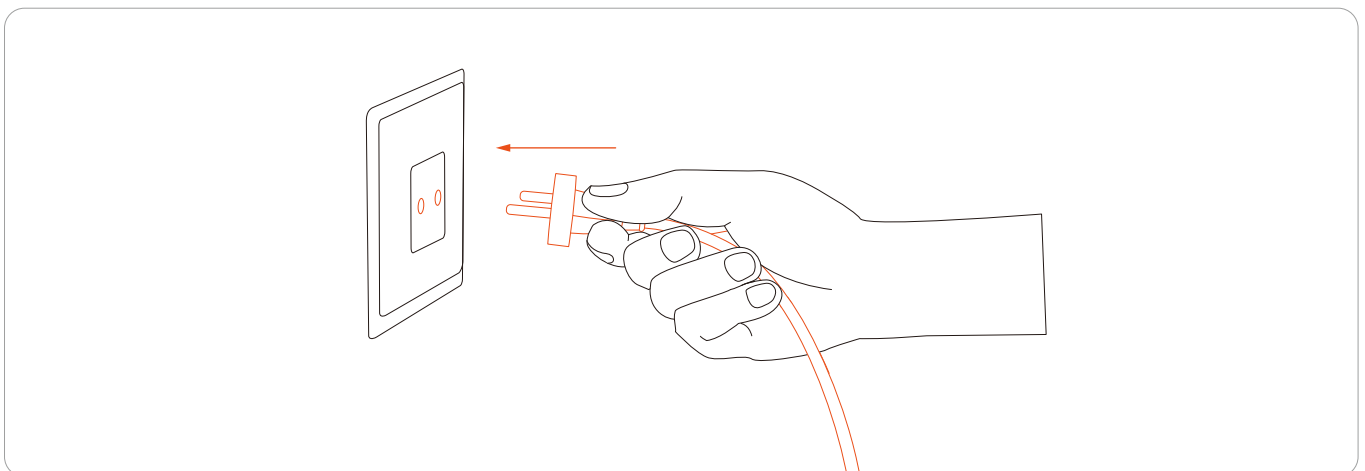



## 2.4.3 Do the Auto-check

### Check the Charging Station

Make sure the mower is not on the charging station. Power on the mower and wait until the light on the charging station turns blue (takes about 5 minutes). If the light does not turn blue, it means you need to relocate the antenna.

### Check the Mower

1. Push the mower into the charging station.

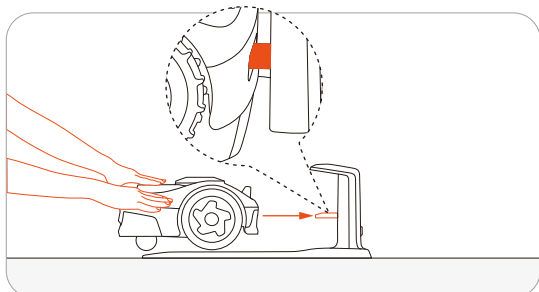

2. Please wait until the light on the mower becomes green.
3. (Optional) If the light does not turn green, go to Settings > MOWER > EFLS 2.0 to verify locations using the Satellite Signal Analyzer. For more information, see 2.3.3 Co-visible Satellites and Satellite Signal Analyzer.

## 2.4.4 Secure Locations

If the auto-check is successful, you can go ahead and secure the location of the charging station. If not, you need to relocate the antenna and the charging station.

1. Secure the charging station with the screws supplied.

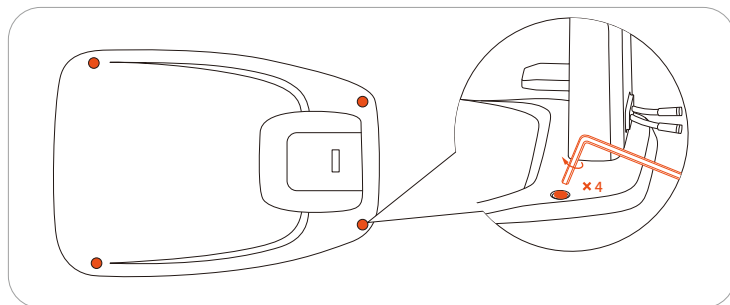

2. Fix the position of the cables on the ground.

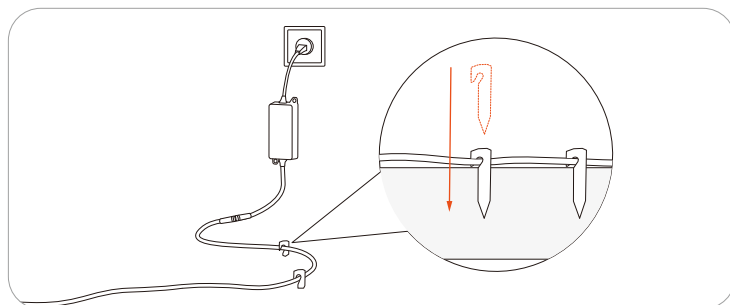

3. Make sure the cables are not placed in the mowing zones or anywhere the mower may pass. Otherwise the cables may be damaged.

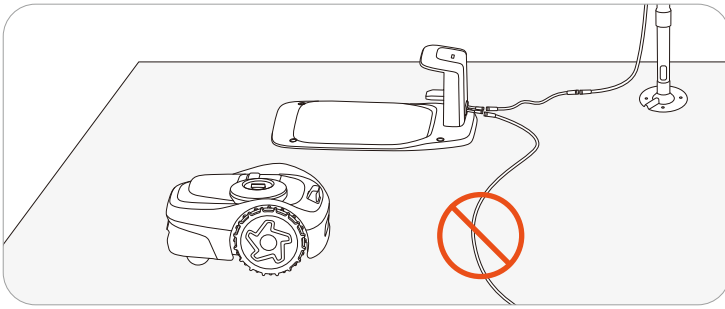

## 2.5 Upgrade to the Latest Firmware

Navimow uses Over-The-Air (OTA) to upgrade the firmware. To fully experience Navimow, prior to use, please upgrade to the latest firmware. Go to Settings>MOWER>Firmware version.

After activating the mower, maintain the network connection state, follow the guidance in the pop-up window, and wait for 10-30 min to automatically complete the firmware upgrade depending on the network conditions. During this process, please do not power off or perform other operations. You can start using it after the app prompts that the upgrade is successful.

## 2.6 Map out the Work Area

### 2.6.1 Map out the Boundary

- 1 Make sure the mower is powered on. With Bluetooth connection, your phone will connect to the mower automatically.

Note: If the mower is in lock status, you must enter the PIN code before operating the mower. The default code is 0000 and can be reset via the Navimow app.

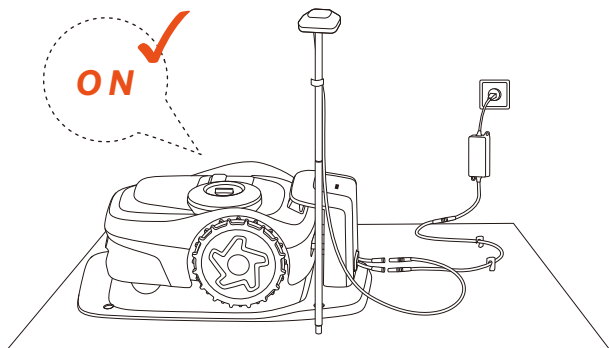

- 2 Tap 'Create a map' to start mapping.

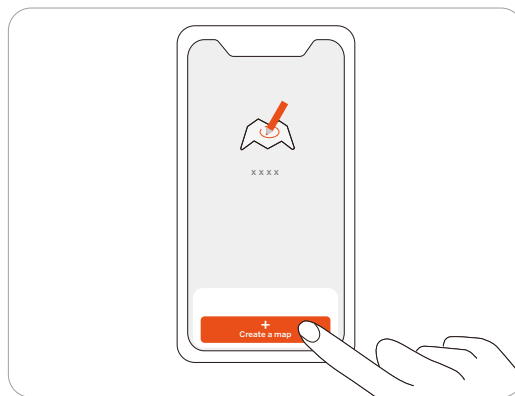

- 3 Calibrate the mower to ensure accurate positioning.

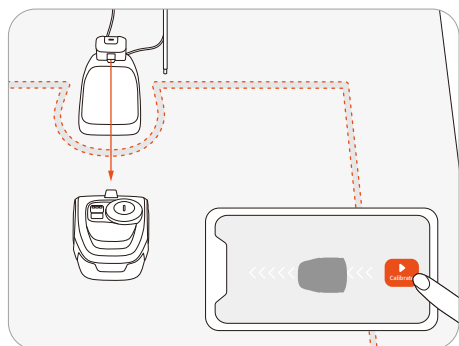

- 4 Find a proper starting point along the edge of your lawn. Keep within 6 m (19.7 ft) from the mower during the mapping process.

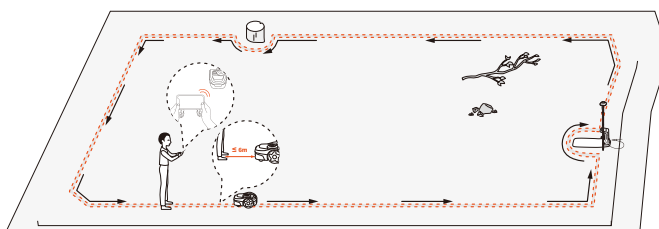

- 5 Walk along the edge.

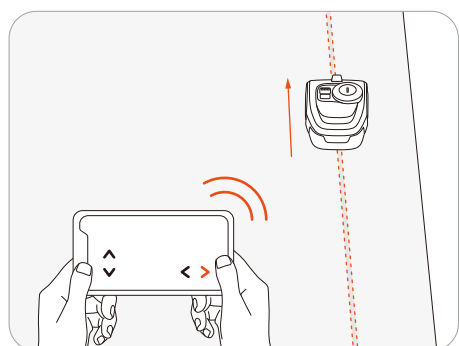

**Angle:** Make sure to follow a straight line with a smooth turning angle of no smaller than 90°.

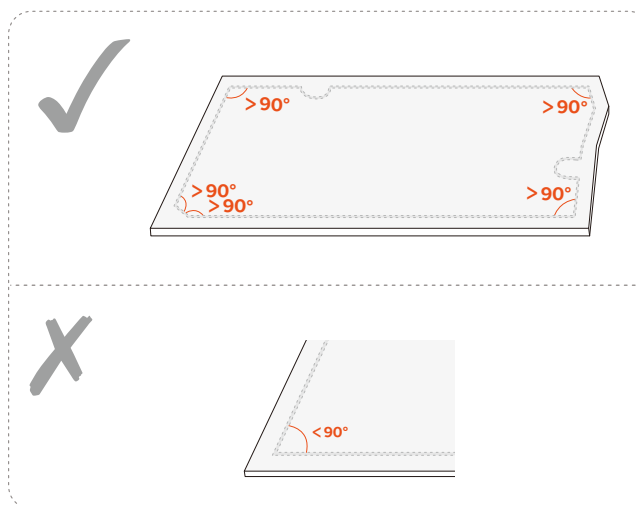

## Standard Boundary

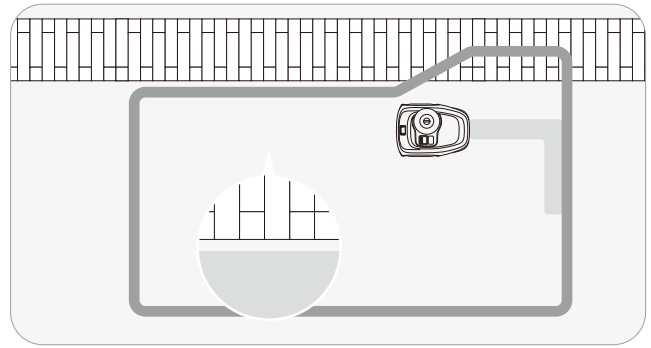
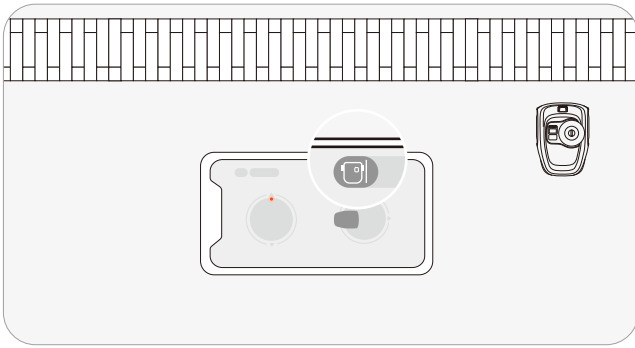

Two boundary options are available for you to choose, based on the actual layout of your lawn. The Standard Boundary is chosen by default and it is recommended to use it for most scenarios. For instructions, follow the guidance in the app.

## Ride-on Boundary

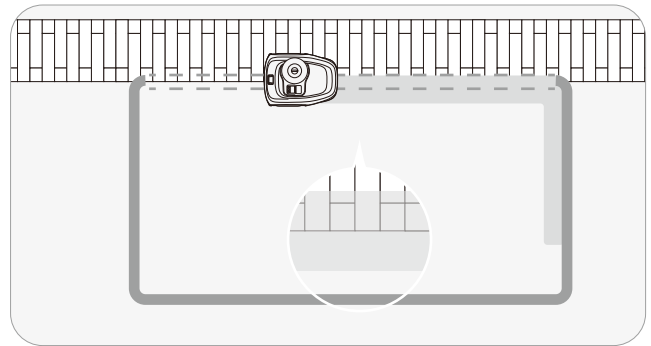
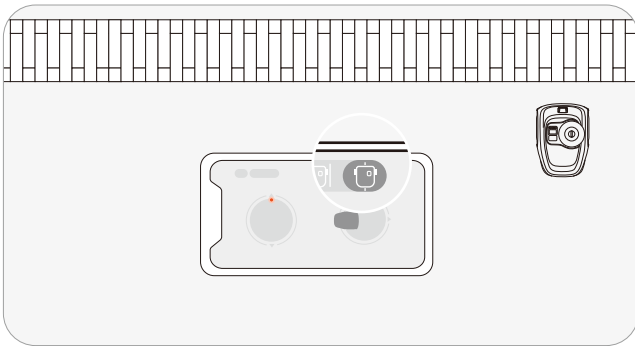

27

For lawns where the grass meets a pathway or pavement at an even level, you may need the mower to ride on the edge in order to fully trim the grass right up to the non-grass area. For such cases, you can choose the Ride-on Boundary. For instructions, follow the guidance in the app.

Note: Ensure the gap between grass and non-grass areas is less than 1 cm (0.4 in).

## Assist Mapping

The camera sensor on the mower captures the physical boundary of the lawn and Assist Mapping will be triggered. Therefore, the mower can create boundaries automatically by navigating along the edges on its own, making mapping easier.

Remote control the mower towards the edges of the lawn. When the camera detects clear lawn edges, you can decide whether to start Assist Mapping.

When the icon on the upper right corner flashes, tap it and start Assist Mapping.

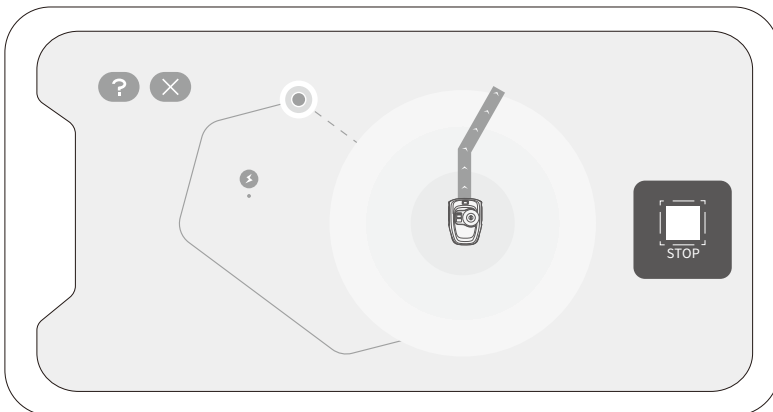

- Keep your phone active and avoid switching to other apps.
- Stay within 6 m (19.7 ft) of the mower during Assist Mapping.
- If the mower behaves abnormally, you can stop Assist Mapping at anytime and manually control the mower.

## 2.6.2 Create an Off-limit Island

When the mower hits a hard obstacle taller than 10 cm (3.9 in) (such as big rocks or a tree trunk), it will reverse and change the direction automatically. However, you need to lay borders for objects that need protection or areas you don't want the mower to enter, e.g., a flowerbed, small trees, lawn decorations, pond, sprinkler heads, emerged roots, etc. If you recently installed a trampoline or grill on the lawn, you can also set an off-limit island to protect it.

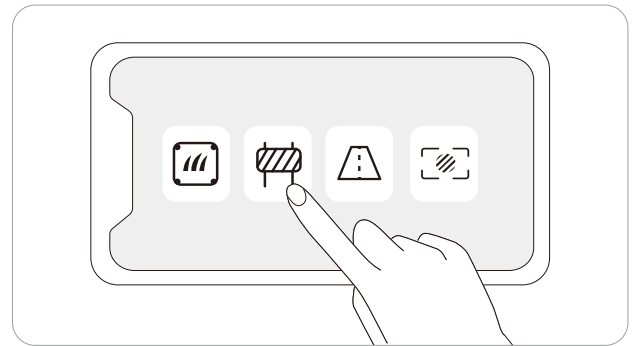

Follow the instructions in the app. When you need to cancel the area (like when you remove the trampoline from the lawn), just delete it via the app.

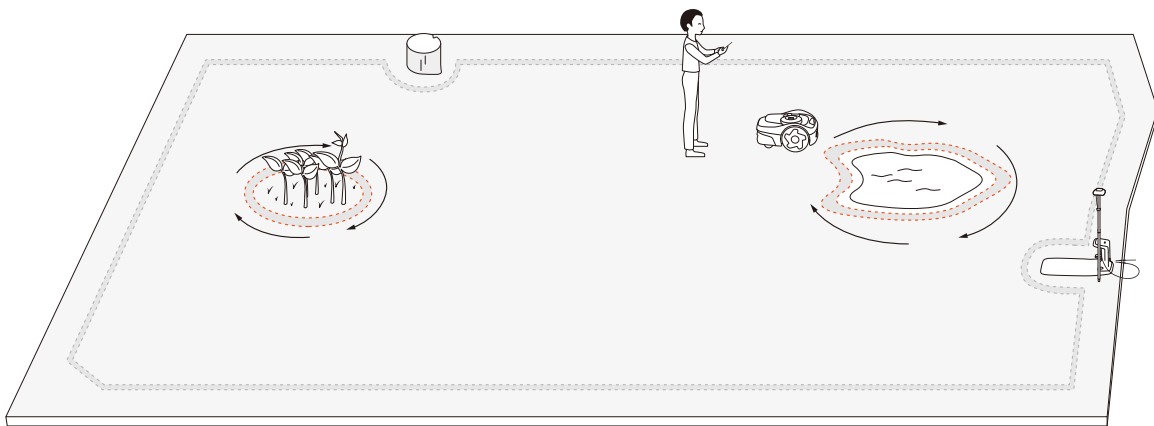

**NOTE:** Make smooth turning angles when setting the islands. The angles should not be smaller than 90°. You also need to walk along the edge when setting the island. For instructions, see 2.6.1 Map out the Boundary.

## 2.6.3 Create a Channel

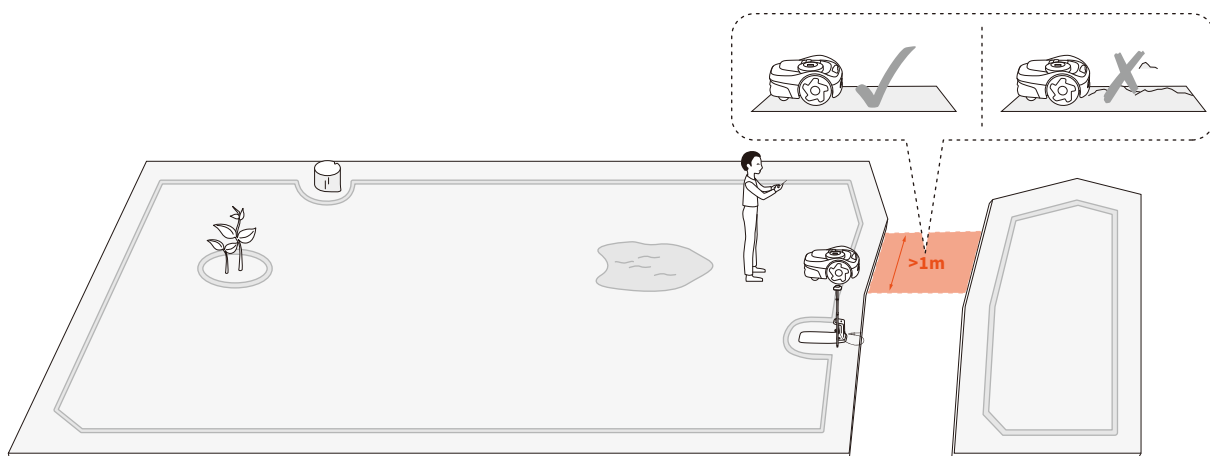

A channel can be created to connect two separate zones or to connect the edge of a lawn to the charging station.

Follow the instructions in the app. If the distance between the charging station and the edge of your lawn is more than 1 m (3.3 ft), you can manually create a channel.

**NOTE:** The channel that you choose to let the mower pass through should be wider than 1 m (3.3 ft)

## 2.6.4 Create a VisionFence-off Zone

A VisionFence-off zone is a place where the mower automatically turns off the camera used for obstacle avoidance, so the mower will directly pass through instead of turning away.

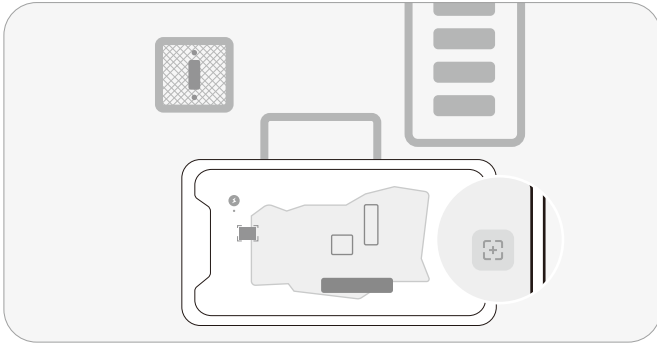

If you need the mower to pass through flat non-grass areas to achieve a thorough cut, you can set up a VisionFence-off zone. These areas can be, for example, stone roads or utility holes, where the visual detection causes the mower to avoid. Follow the instructions in the app. You can adjust the size of a VisionFence-off zone, move it to another place, or delete it.

## 2.6.5 Improve Map Accuracy (optional)

29

To improve your map accuracy, enable the Camera-assisted Positioning in Settings > MOWER > EFLS 2.0 page.

The Camera-assisted Positioning feature uses the EFLS 2.0 technology to improve positioning accuracy. This means the camera sensor is used to collect visual elements to form a map that compensates the loss of GPS signal in certain areas. After you finish creating or editing a map, you can use this feature to correct map inaccuracy due to poor GPS signal during mapping. This improves the map quality and avoids leaving grass uncut or the mower going out of boundaries. The improvement starts automatically once the mower returns to the charging station. Follow the instructions on the app. You can view the progress in the status bar on the home page. The result can be one of the following:- Map accuracy improved: The boundaries, off-limit islands, and channels are all now updated with more accurate positioning.- Map accuracy failed to be improved: The map has large areas with very poor GPS signal. The Camera-assisted Positioning failed because the antenna is not at a proper location. To install the antenna somewhere else, you can try using the Satellite Signal Analyzer to find a better location.

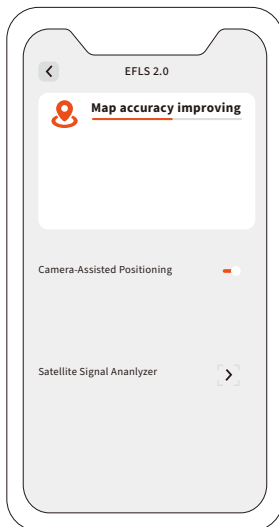

## 3. Daily Use

### 3.1 Mow

#### 3.1.1 How Does Navimow Mow

##### **Mowing along the boundary**

Your mower mows along the boundary when it starts a mowing task. If the boundaries of your lawn have complex surroundings, to avoid risks, you can disable it by turning off the 'Edge Mowing' switch from Map management > Edit > Edge Mowing for each zone.

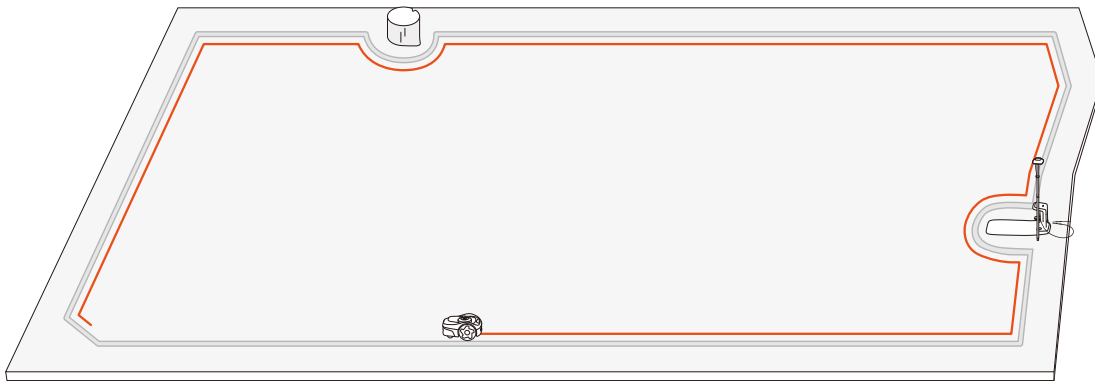

##### **Mowing with systematic patterns**

Inside the work area, the mower will mow the lawn along a planned path calculated by an algorithm for maximum efficiency.

The mower can change its mowing directions according to your choices. This avoid repetitive mowing tracks. To customize mowing directions for each mowing zone, see Customize mowing directions in 3.1.2 Manage Multiple Zones.

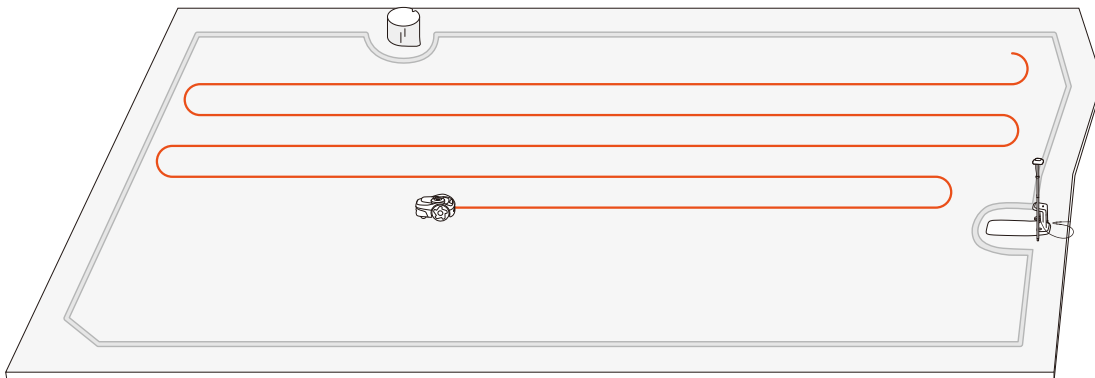

### 3.1.2 Manage Multiple Zones

You can create multiple zones for your map, each zone with its own unique name and a customized mowing direction, and mowing schedule. For manual mowing, you can select to mow all zones or only some of them. For scheduled mowing, you can set up schedules for all or selected zones.

A zone is automatically created after the boundaries of an work area is mapped out. You can continue to create multiple zones (12 maximum) and connect them with channels. For instructions, see 2.6.3 Create a Channel.

#### Rename the zones

1. Tap to select a zone.
2. Tap 'Edit' and customize settings for the selected zone.
3. Tap the 'Rename' icon to set a name for the zone.

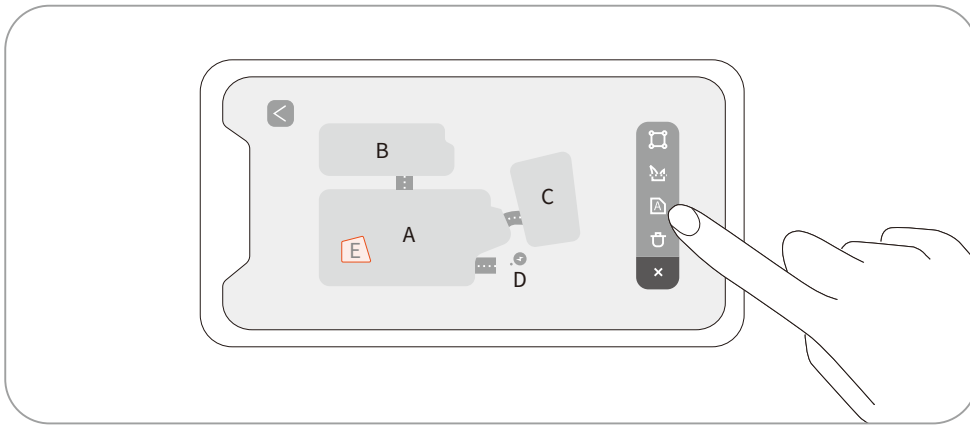

#### Customize mowing directions

The mower can automatically change its mowing direction according to your choices from Map management > Edit > Mowing direction. You can choose one or more directions so that mower changes by 10 degrees every time it finishes a round of mowing.

#### Create or modify mowing schedules

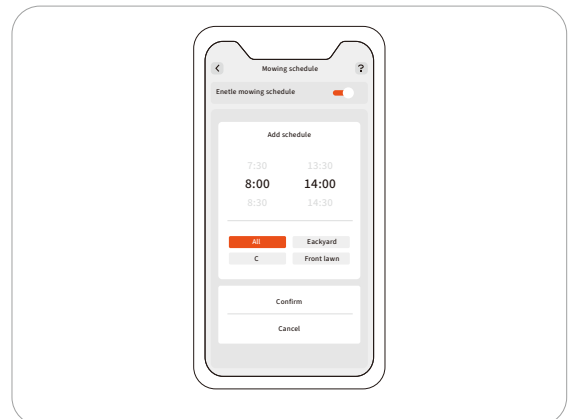
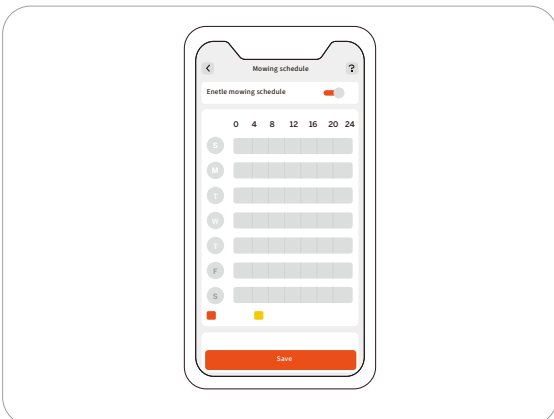



1. Go to Settings > MOWER > Mowing schedule.
2. Select a day to set up a schedule.
3. Set the start time and end time of the schedule.
4. Select which zone(s) to apply the schedule.
5. Tap 'Confirm' to save the settings.

### Enable or disable mowing schedules

You can disable the mowing schedules if you don't want the mower to follow the schedule.

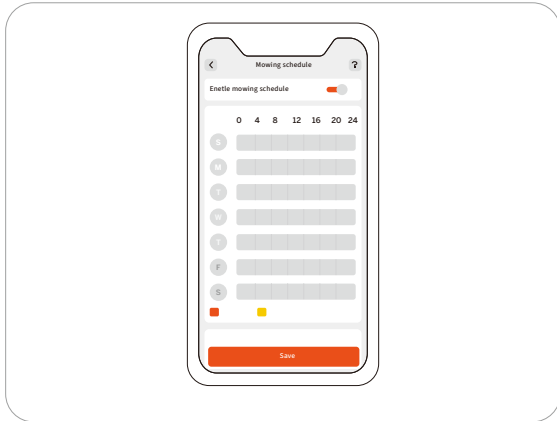

### Enable or disable mowing cycle

When disabled, if the mowing progress in the selected zones reaches 100%, the mower will stop mowing and return to the charging station even if the scheduled end time has not yet arrived.

When enabled, if the mowing progress in the selected zones reaches 100%, the mower will start a new round of mowing and keeps mowing until the scheduled end time arrives.

## 3.2 Navimow App

### 3.2.1 Introduction

**The Navimow app is an important part of Navimow, you can use the app to:**

1. Bind and activate the mower.
2. Create a map (work area) with multiple mowing zones.
3. Check the status and work progress of the mower, remotely control the mower to start, stop or return to the charging station, etc.
4. View and change mower work settings (map management, mowing schedules etc).
5. View and change mower security/function settings (Mowing at night, Reset PIN code, light settings, Anti-theft, etc.).
6. Update firmware, and change network connection.
7. Unbind and retain or clear user data.
8. Get user materials and after-sales support via Live Chat.

### 3.2.2 Download, Register, Log in

1. Search and download the Navimow app through the Apple APP store or Google Play Store.
2. Register and log in to your account.
3. Turn on the Bluetooth on your phone and make sure your phone has a network signal.

#### NOTES:

1. If you have registered an account through other services of Segway-Ninebot, you can log in to the Navimow app with the account and vice versa.
2. If you deactivate your Navimow account, all data related to Segway-Ninebot will be deleted.
3. During use, the Navimow app will ask you for Bluetooth (iOS/Android), location (iOS/Android), and Wi-Fi access (Android). To ensure normal use, please grant the above accesses.
4. If you use Navimow with an iOS mobile device, when configuring the mower's Wi-Fi network for the first time, please make sure that your mobile phone is connected to the same Wi-Fi network.

### 3.2.3 Update Navimow app and Firmware

To experience the latest features and updates, always keep your Navimow app up-to-date. You will receive a notification to remind you when there is a new version of the app.

To manually check firmware updates, go to Settings>MOWER>Device management> Firmware version.

To upgrade the firmware successfully, the following conditions need to be met:

- The mower is in the charging station.
- The mower is connected to a network and the signal is strong (through 4G or Wi-Fi).
- The battery power is more than 20%.
- There is no mowing task scheduled in the next hour.

For more information about upgrading firmware, see 2.5 Upgrade the Mower to the Latest Firmware.

## 3.2.4 Basic Operations

### Bind your mower

After registration and login, tap 'Add device' to bind your mower to your account.

For more information, see 2.2 Activate the Mower.

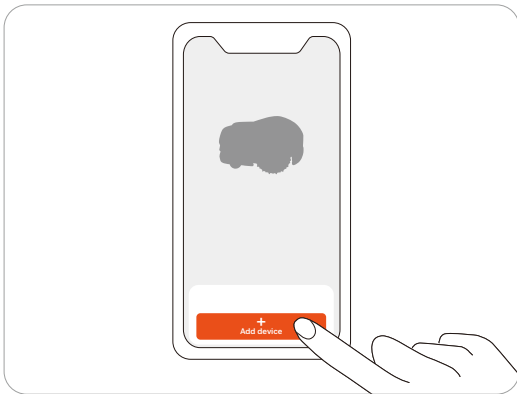

### Create a map

Before mowing your lawn with Navimow, you need to create a work area (map) using the Navimow app. Tap 'Create a map', and follow the instructions in the app. For detailed steps and tips, see 2.6 Map out the Work Area.





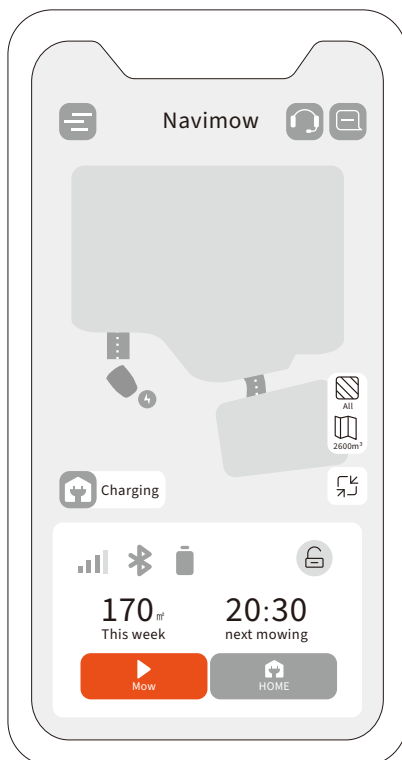

Maps can also be edited or deleted on the Settings page. For more information, see 3.4.1 Edit the Map.

34

### View status on the home page

The home page shows the status of the mower, the work progress, and mowing tasks. You can choose to view the work area of all zones or selected zones, start or pause mowing tasks, and send the mower home. You can also go to the Live Chat, the notification page and the settings page by tapping the icons on the top of the home page.



All/Zone		Displays if the current mowing task is applied to all zones or specific zones
Map management		Navigates to the Map management page
Battery level		Battery level and charging status
Lock status		Locked/Unlocked. See How to enter PIN code in 1.6 Parts and Functions
Bluetooth		Bluetooth connected. When disconnected, tap to reconnect.
Connectivity		Displays the network that the mower is connected to (WiFi or cellular), and the signal strength
Mower status		Ongoing tasks/Upgrading firmware/Charging/On the way back to the charging station/Unknown status
		Map accuracy is being improving/has been improved
Notifications		Notifications from the mower and the app
Settings		Settings of the mower and the app
Live Chat		Entrance to the Help Center where you can find user materials and Live Chat for questions or requests

## 3.3 App Notifications

### 3.3.1 System Notifications

Latest news and updates from Navimow team.

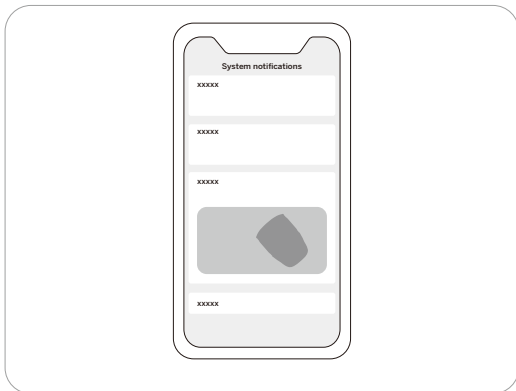

### 3.3.2 Device Notifications

The mower will send you device notifications in the following situations: work status update (such as mowing completed), blade replacement, unexpected behaviors, abnormal position, etc.

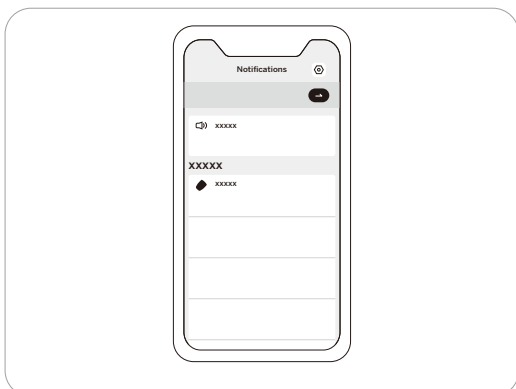

### 3.3.2 Pop-up Messages

Pop-up messages appear at the center of the screen. For example, an error code message appears if an error has occurred.

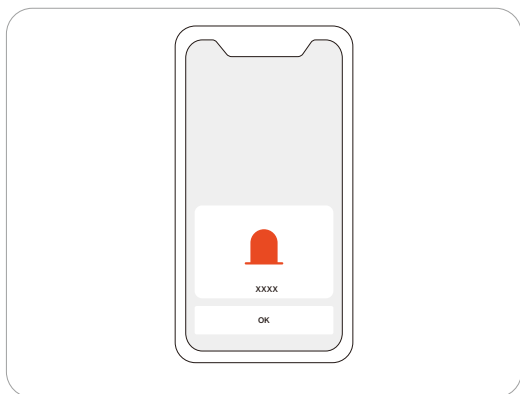

## 3.4 Mower Settings

### 3.4.1 Edit the Map

You can edit or delete the map elements in Settings > MOWER > Map management. Make sure your phone is connected to the mower via Bluetooth.

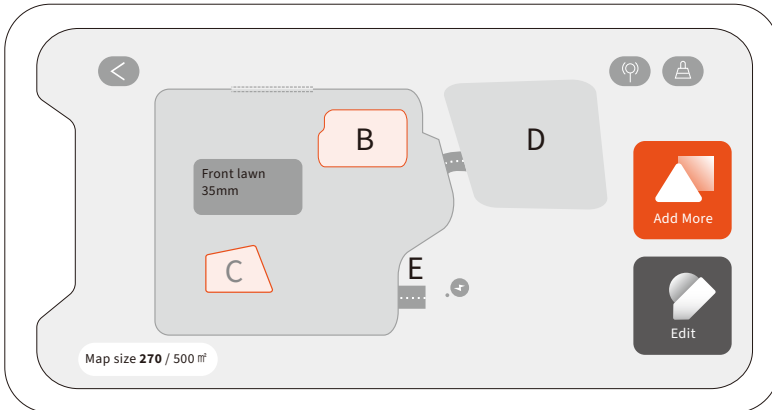

By tapping 'Edit' you can: Delete or adjust the boundary of mowing zones, off-limit islands, channels, and VisionFence-off zones. For the definition of boundary, off-limit islands, channels, and VisionFence-off zones, see 2.6 Map out the Work Area.

**NOTE:** When you delete a zone, the elements associated with the zone are also deleted.

### 3.4.2 Reset the PIN Code

The default PIN code is 0000. You can reset the PIN code in Settings > MOWER > Reset PIN code.

**NOTE:** It is recommended that you reset the PIN code after activating your mower.

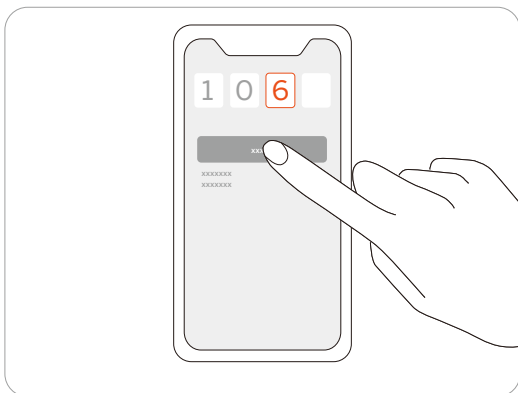

### 3.4.3 Add, Switch, Unbind Devices

You can add multiple mowers from Settings > MOWER > Switch / Add Device and switch to another mower by selecting another serial number (SN) in the list. When unbinding the mower, you need to verify your identity by entering the hidden characters of your email address or phone number.

You can choose to retain or clear your user data after unbinding the mower.

### 3.4.4 Enable and Use Anti-theft

The Anti-theft function can precisely locate Navimow and effectively prevent accidents such as mower theft. When moving out of a designated area, Navimow will sound an alarm and you will receive a notification on the app simultaneously. Go to Settings > MOWER > Anti-theft.

When Anti-theft is on, you can set the geofence and check Navimow's location in the map in real time. If the mower runs out of battery and powers off on the way back to the charging station, you can find where it stopped via the app.

You need to purchase and install Navimow Access+ to enable the Anti-theft feature. For more information about activate the Navimow Access+, see 1.8 Accessories.

#### NOTES:

1. If Anti-theft is enabled, you need to enter PIN on the mower before powering off the mower.
2. If Anti-theft is accidentally activated, you need to enter PIN on the mower to disable the alarm and end the push notification.
3. Anti-theft is only available with 4G connection. Make sure you are using cellular network and the 4G service has not yet expired.

### 3.4.5 Adjust the Mowing Height

To adjust the mowing height, turn the knob on the top of the mower so that the arrow points to the height that you need to set.

**NOTE:** The mowing height applies to all mowing zones.

For i105E and i108E, the global cutting height can be set between 2 cm and 6 cm.

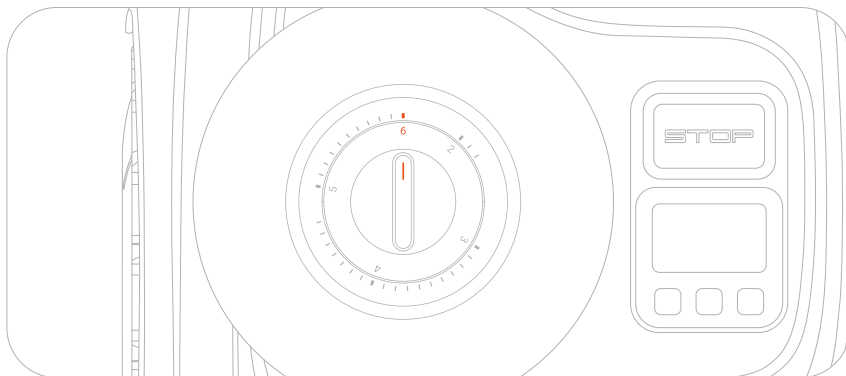

For i105N and i110N, the global cutting height can be set between 2 inches and 3.6 inches.

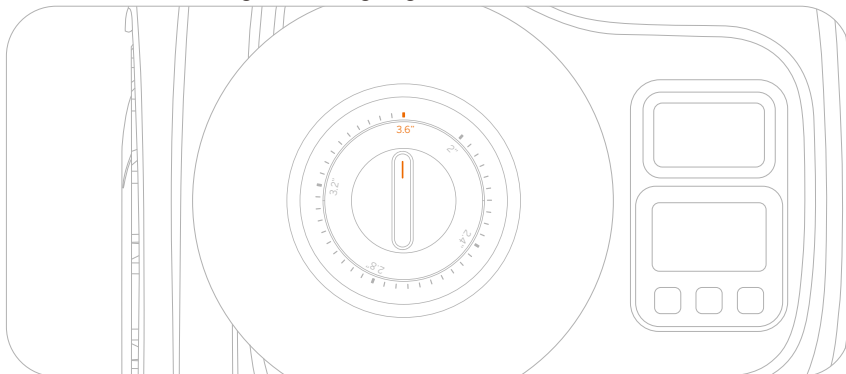

### 3.4.6 Sound and Light Settings

The sound effects are enabled by default. When you disable it, the mower will not make any sounds of notification during mowing and charging.

You can enable the 'Night mode' to adjust the nighttime brightness level for the lights on both the charging station and the mower. The lights

### 3.4.7 VisionFence Settings

You can enable the 'Mowing at night' switch to let the mower mow at night with the VisionFence turned off. The obstacle avoidance performance might be limited in some complex yards. When the switch is disabled, the mower will go back to the charging station.

You can enable the Channel Sense switch and the mower can "see" the surroundings and intelligently passes through by actively avoiding obstacles or other objects that are distinct from the ground. Even when the GPS signal is poor around the channel, the mower can still manage to pass through with visual detection.

### 3.5 Network Settings

You can manage the network used by Navimow on the Network management page. On the Wi-Fi settings page, you can view the currently connected Wi-Fi network or reconnect to the Wi-Fi. Make sure your phone and the mower are connecting to the same Wi-Fi network.

If you have installed the Navimow Access+, the 4G module, go to Settings > MOWER > Network management to switch between Wi-Fi and 4G networks.

### 3.6 App Settings

Go to Settings > APP to browse and adjust the Navimow app-related settings.

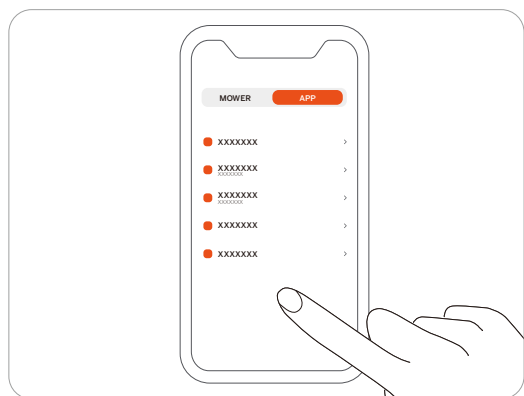

### Account and security

You can check your bound email address or mobile number, change the password, download the data, and delete your account.

### Language

You can set the language to the one that you need. Up to now, 22 languages are supported, which are English, German, French, Dutch, Italian, Swedish, Norwegian, Finnish, Danish, Portuguese, Spanish, Czech, Slovak, Polish, Estonian, Lithuanian, Latvian, Bulgarian, Hungarian, Croatian, Romanian, and Slovenian.

### Help and feedback

You can view the latest user materials, tutorial videos, FAQ and contact us for support via Live Chat here.

### Units

You can switch between the metric units and the imperial units here.



## Time zone and country

You can manually select your local time zone and country or region so that the mowing schedules can follow your local time. You can enable the Daylight Saving Time mode if your region follows this practice. This way, the mower can automatically adapt to your local time during summer and winter.

## About

You can view the current app version, the latest User Agreement and Privacy Policy here.

## Log out

You can log out of your account here, and your data will not be deleted after logging out.

# 4. Maintenance

To achieve better mowing results and increase the service life, be sure to keep the mower clean and the blades in good condition. Inspection and maintenance should be carried out by an adult every week. Any damaged or worn parts should be replaced. **DO NOT perform maintenance when wearing open sandals or barefoot. Always wear long trousers and work shoes when servicing the mower.**

## 4.1 Cleaning

40

Use a soft brush or cloth to clean the exterior of the mower thoroughly. DO NOT clean with alcohol, gasoline, acetone, or other corrosive/volatile solvents. These substances may damage the appearance and internal structure of your mower.

For proper docking, periodically inspect and clean the charging station from debris and mud. Make sure all connecting parts of the charging station, the extension cable, and the power supply are not blocked.

### A. Chassis and blade disc

If the chassis and blade disc are dirty, use a brush or a water hose to clean. DO NOT use a high-pressure washer. At the same time, make sure that the blade disc rotates freely and the blades can pivot freely.

CAUTION: High-pressure water can leak into the sealings and damage electronic and mechanical parts.

### B. Blade fender

Check the blade fender regularly. If mud, grass clippings or other objects gather on the blade fender, remove them with a dry brush or scraper.

### C. Rear wheels (universal wheels)

Inspect and clean universal wheels regularly. If the wheels are stuck, clean off the mud and lubricate the wheels.

### D. Front wheels

Check and clean the front wheels regularly. Remove grassing clippings or other objects. If the wheels are stuck with mud or dirt, wash them with a water hose.

### E. Camera lens

Check and clean the camera lens regularly. A stained camera lens may affect the performance of the mower.

### F. Charging port

Check if grass clippings or dirt is stuck inside the charging port, and clean them in time. Otherwise, the mower cannot be charged due to poor contact.

### WARNING

- Before cleaning, make sure the mower is powered off.
- Before turning the mower upside down, it must be powered off.

## 4.2 Replace Blades

The blade disc automatically changes its rotation direction multiple times during mowing to prevent excessive wear on one side. If the mower is used on a regular basis, it is recommended to replace the blades and screws every 1–2 months to ensure safety and better mowing results. Replace all three blades and their screws at the same time for a safe cutting system.

Wet grass is more likely to stick to the blades and the bottom part of the mower, which can affect its performance and require more frequent cleaning. For optimal results and to maintain your lawn's health, it is best to avoid mowing during heavy rain or when the lawn is excessively wet.

It is normal for grass clippings to accumulate on the blades during mowing. The design of the blades allows them to continue rotating smoothly around the screws, even when small amounts of clippings or debris are present. This occasional buildup of clippings should not negatively impact the mower's ability to effectively cut grass. The mower is designed to perform its function despite minimal clippings collecting on the blades over time.

While grass clippings can be removed when replacing the blades if desired, immediate action is not required unless an excessive amount of clippings are stuck on the blades.

### WARNING

- Wear protective gloves when you inspect or service the blade.
- DO NOT use an electrical screwdriver to install or loosen the blade disc. Only use the right type of screws and original blades as approved by Navimow. Blade model: HA002E.
- DO NOT reuse the screws. Doing so can cause serious injury.

### How to replace the blades

- 1 Turn off the mower.
- 2 To avoid scratching, place the mower on a soft and clean surface in an upside-down position.
- 3 Use a cross-tip screwdriver to loosen the three screws.
- 4 Remove the screws and blades.

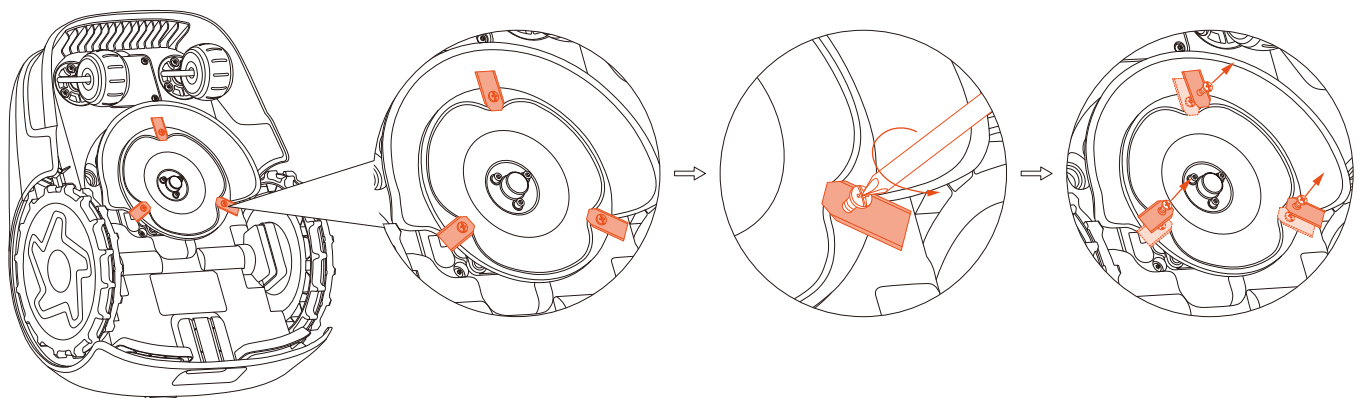

5 Fasten the new blades and screws (Torque: 1 N·m). Make sure the blades can pivot freely.

Note: After fastening the blades and screws the blades will still seem loose. This is normal as the blades need to spin during mowing. The blades are intentionally designed to rotate freely when attached to the blade disc. During mowing, the spinning blade disc generates centrifugal force, which causes the blades to point outward. This outward orientation allows the blades to effectively cut grass.

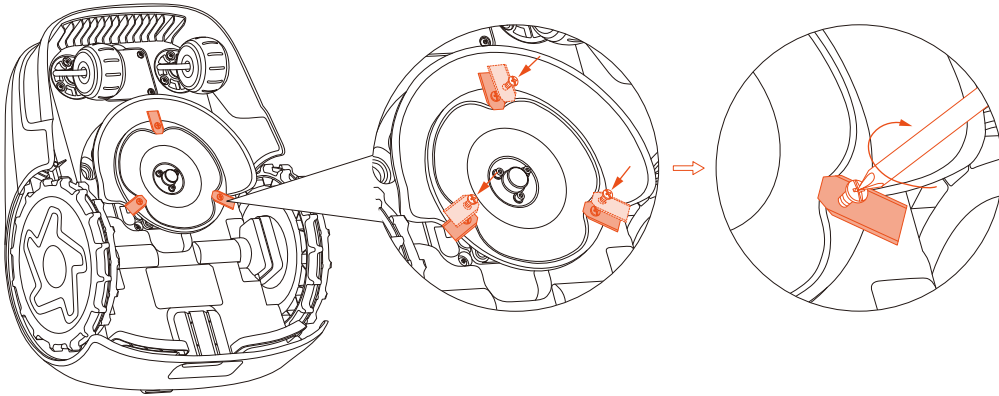

## 4.3 Transportation

To protect the mower, use the original packaging for long-distance transportation. Before lifting, moving, or transporting the product, turn it off. Handle with care and avoid violent force, such as throwing and heavy pressure. Never pick up or carry the mower while the motor is running.

### How to move or lift properly

Carry the mower by the handle, with the blade disc facing away from your body.

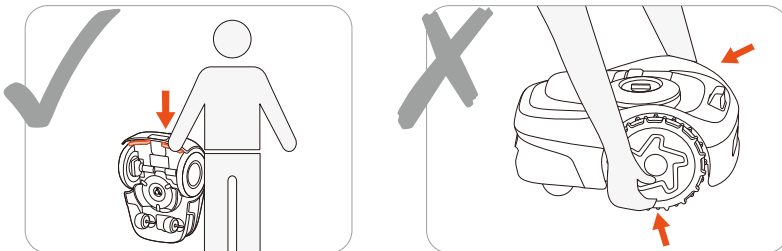

### CAUTION:

To avoid damage to the mower and/or the charging station, DO NOT lift the mower by the handle when it's parked in the charging station. Pull off the mower from the charging station before lifting the mower.

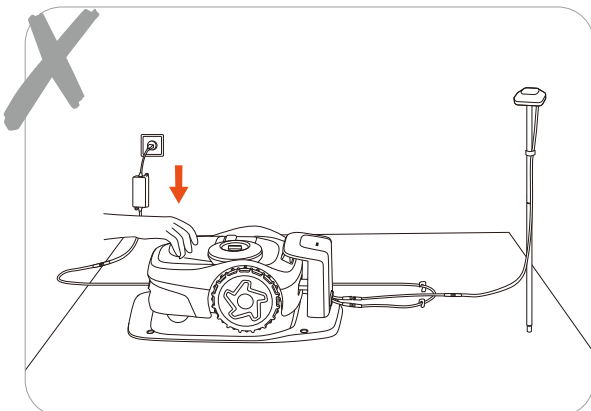

## 4.4 Battery

- Power off the mower and charge its battery to 85% or higher before storage to avoid over-discharge and damage to the electrical components. Charge the mower every 120 days for long-time storage.
- Battery damage caused by over-discharge will not be covered by the Limited Warranty.
- DO NOT use or store the battery under extreme temperature conditions, i.e., above 50°C (122°F) or below -20°C (-4°F).
- Temperature protection will be activated at 0°C (32°F)/53°C (127°F), the battery won't be charged unless the temperature reaches 3°C (37°F) or above/reduces to 49°C (120°F) or below.
- When the battery temperature is too high or too low, the mower will not start mowing. You will also receive a push notification in the Navimow app.

**NOTE:** The battery life depends on how often the product is used and the total working hours. When the operation time is significantly shorter than usual per full charge or the lawn is not well-cut, consider contacting the after-sales service to replace the battery.

## 4.5 Power Supply

- Disconnect the power supply:
  - Before clearing a blockage;
  - Before checking, cleaning or working on the machine;
  - After striking a foreign object to inspect the machine for damage.
- Regularly examine the cord, plug, enclosure and other parts. If any damage or signs of aging are found, stop using immediately.

### WARNING

- DO NOT operate a damaged power supply. If the supply cord is damaged, it must be replaced by the manufacturer, its service agent or similarly qualified persons in order to avoid a hazard. If the extension cable is defective, please replace it with the 10-meter long cable as approved by Navimow.
- DO NOT connect a damaged cord to the power supply or touch a damaged cord or extension cable before it is disconnected from the power socket. Damaged cords can lead to contact with live parts.
- DO NOT use the power supply with any other product or battery, otherwise there will be risks of personal injury, fire or electrical shock. Product safety cannot be guaranteed with other than original batteries.
- DO NOT charge when the battery is leaking.
- Keep the extension cable away from moving hazardous parts to avoid damage to the cords which can lead to contact with live parts.

### **Recommendation**

Connect the mower and/or its peripherals only to a supply circuit protected by a residual current device (RCD) with a tripping current of not more than 30 mA.

## 4.6 Storage

- Before storage, power off the mower and charge its battery to 85% or higher to avoid over-discharge, which will cause permanent damage.
- Store in a cool and dry place indoors. Exposure to sunlight and extreme weather (both hot and cold) will accelerate the aging process of the components and may permanently damage the battery.
- Keep the mower, charging station and power supply away from heat sources (such as stoves, radiators, etc.) or chemicals. Protect the power supply from moisture and keep it in a well-ventilated place.

### WARNING

When there is a risk of a thunderstorm, unplug the power supply from the power socket. Disconnect all cables and wires connecting to the charging station. Reconnect when there is no longer a risk of thunder.

## 4.6.1 Winter Storage

For optimal performance and longevity, it is recommended to store your Navimow during winter months when it will not be in use. By properly storing your Navimow, you can protect it from harsh winter conditions and ensure its functionality when spring comes. Cold weather, including freezing temperatures and snow, can damage sensitive components of the mower. Follow the steps below:

### Get all the tools you need

Silicone pegs for marking the location of the charging station, a screw driver, the Navimow box and packaging materials.

### Put the mower in storage

1. Pull the mower off the charging station. Note: Make sure the mower has at least 85% battery left.
2. Power off the mower.
3. Disconnect the power supply and the antenna.
4. Put your protective gloves on and remove the blades with caution.
5. Turn the mower upside down and clean it with a brush.
6. Use a water hose to wash away the dirt and leave the mower to get dry.

### Put the charging station and Navimow Garage S in storage

1. Uninstall Navimow Garage S from the charging station and put the garage away.
2. Unscrew the ground screws off the charging station.
3. Mark the location with the silicone pegs.
4. Turn the charging station upside down and clean it with a brush. Use a water hose to wash away the dirt and leave the charging station to get dry.
5. Put away the charging station.

### Put the antenna in storage

If the antenna is installed on a wall or roof, use a plastic bag or a cover to cover up the antenna. If the antenna is installed from the ground, follow the steps below:

1. Remove the antenna and the pole.  
Note: Keep the three-pronged part at its place.
2. Put away the cable for the antenna.

## 4.6.2 Spring Restorage

To restore your Navimow and all its installations in spring, follow the steps below:

1. Remove all coverings from the mower.
2. Ensure that the charging station is clean and free from dirt. Remove the silicone pegs that marked the location and secure the screws to the ground.  
Note: The difference between the installed position and last year's position should not exceed 5 cm.
3. Reconnect the cables that were disconnected during the winter. Check the cables for any damage or breaks and repair as needed.  
Note: Check the blades for sharpness and replace them if necessary. Check and clean the camera lens to ensure proper functionality.
4. Finally, power on the mower and test if the mower is bound to the app and works properly.

## 4.7 Recycling and End-of-Life Disposal

DO NOT treat this product as domestic waste. For recycling information, contact your domestic waste service, your municipality, or point of sale.

### WARNING

DO NOT dispose of this product in a landfill, by incineration, or by mixing with household trash. Danger or serious injury can occur because of the electrical components.

## 5. FAQ & Troubleshooting

If you encounter any product or app-related problems, common issues and questions, check out the FAQ articles from <https://segway-navimow.my.site.com>

## 6. Important Information

### 6.1 EC DECLARATION OF CONFORMITY

#### Manufacturer

Name: Navimow B.V.

Address: Dynamostraat 7, 1014BN Amsterdam, The Netherlands

#### Authorized Representative

Name: AR Experts B.V.

Address: P.O. Box 5047, 3620 AA Breukelen, The Netherlands

#### Object of the declaration

Generic designation: Robotic Lawnmower

Product name: Navimow i Series

Type/model: i105E/i108E

Serial number: S4RE x yyyy x yyyy/S4TH x yyyy x yyyy/S4RK x yyyy x yyyy/S4TN x yyyy x yyyy/S4RL x yyyy x yyyy/S4TP x yyyy x yyyy  
("x" indicates any letter from A-Z except O and I, "y" indicates any letter from A-Z except O and I or any number from 0-9)

This Declaration of Conformity is issued under the sole responsibility of the manufacturer.

The object of the declaration described above is in conformity with the following EU Directives:

1. Radio Equipment Directive (2014/53/EU)
2. Machinery Directive (2006/42/EC)
3. RoHS Directive (2011/65/EU) and amending directive ((EU)2015/863)

Conformity with these Directives has been assessed for this product by demonstrating compliance to the following harmonized standards and/ or technical specifications:

EN 60335-1:2012+A11:2014+AC:2014+A13:2017+A1:2019+A14:2019+A2:2019+A15:2021

EN 50636-2-107:2015+A1:2018+A2:2020+A3:2021

EN IEC 61000-3-2:2019+A1:2021

EN 301 908-1 V13.1.1

EN 61000-3-3:2013+A1:2019

EN 301 489-1 V2.2.3

EN IEC 55014-1:2021

EN 301 489 - 3 V2.2.0

EN IEC 55014-2:2021

EN 301 489-17 V3.2.4

EN 300 220-1 V3.1.1

EN 301 489-19 V2.1.1

EN 300 220-2 V3.1.1

EN 301 489-52 V1.2.1

EN 300 328 V2.2.2

EN 301 511 V12.5.1

EN 303 413 V1.1.1

EN IEC 62311:2020

EN 50665:2017

EN IEC 63000:2018

EN 62133-2:2017

Signed for and on behalf of: Navimow B.V.

Place: Changzhou, China

Date: 2023-11-10

Name: Crystal Zhuang

Function: Certification Manager

Signature: *Crystal Zhuang*

## 6.2 UKCA DECLARATION OF CONFORMITY

**Manufacturer**

**Name:** Navimow B.V.

**Address:** Dynamostraat 7, 1014BN Amsterdam, The Netherlands

**Object of the declaration**

**Generic designation:** Robotic Lawnmower

**Product name:** Navimow i Series

**Type/model:** i105E/i108E

**Serial number:** S4RJ x yyyy x yyyy/S4TM x yyyy x yyyy

("x" indicates any letter from A-Z except O and I, "y" indicates any letter from A-Z except O and I or any number from 0-9)

This Declaration of Conformity is issued under the sole responsibility of the manufacturer.

The object of the declaration described above is in conformity with the following UK legislations:

1. Radio Equipment Regulations 2017
2. Supply of Machinery (Safety) Regulations 2008
3. The Restriction of the Use of Certain Hazardous Substances in Electrical and Electronic Equipment Regulations 2012

Conformity with these Directives has been assessed for this product by demonstrating compliance to the following designated standards and/ or technical specifications:

BS EN 60335-1:2012+A11:2014+AC:2014+A13:2017+A1:2019+A14:2019+A2:2019+A15:2021

BS EN 50636-2-107:2015+A1:2018+A2:2020+A3:2021

BS EN IEC 61000-3-2:2019+A1:2021	EN 301 908-1 V13.1.1
BS EN 61000-3-3:2013+A1:2019	EN 301 489-1 V2.2.3
BS EN IEC 55014-1:2021	EN 301 489 - 3 V2.2.0
BS EN IEC 55014-2:2021	EN 301 489-17 V3.2.4
EN 300 220-1 V3.1.1	EN 301 489-19 V2.1.1
EN 300 220-2 V3.1.1	EN 301 489-52 V1.2.1
EN 300 328 V2.2.2	EN 301 511 V12.5.1
EN 303 413 V1.1.1	BS EN IEC 62311:2020
BS EN 50665:2017	BS EN IEC 63000:2018
BS EN 62133-2:2017	

Signed for and on behalf of: Navimow B.V.

**Place:** Changzhou, China

**Date:** 2023-11-10

**Name:** Crystal Zhuang

**Function:** Certification Manager

**Signature:** *Crystal Zhuang*



# 6.3 Certifications

## European Union Compliance Statement

### Information on Disposal for Users of Waste Electrical & Electronic Equipment



This symbol on the product or on its packaging indicates that used electrical and electronic products should not be mixed with unsorted municipal waste. For proper treatment, it is your responsibility to dispose of your waste equipment by arranging to return it to designated collection points.

Disposing of this product correctly will help save valuable resources and prevent any potential negative effects on human health and the environment, which could otherwise arise from inappropriate waste handling.

To return your used device, please use the return and collection systems or contact the retailer where the product was purchased, which is free of charge, please contact your local authority for further details of your nearest designated collection point.

Penalties may be applicable for incorrect disposal of this waste, in accordance with your national legislation.

### Information on Disposal for Users of used batteries



This symbol means that batteries and accumulators, at their end-of-life, should not be mixed with unsorted municipal waste. Your participation is an important part of the effort to minimize the impact of batteries and accumulators on the environment and on human health. For proper recycling you can return this product or the batteries or accumulators it contains to your supplier or to a designated collection point, which is free of charge.

Disposing of this product correctly will help save valuable resources and prevent any potential negative effects on human health and the environment, which could otherwise arise from inappropriate waste handling.

Penalties may be applicable for incorrect disposal of this waste, in accordance with your national legislation.

there are separate collection systems for used batteries and accumulators.

Please, dispose of batteries and accumulators correctly at your local community waste collection/recycling center.

### Restriction of the use of certain hazardous substances (RoHS) Directive

Navimow B.V. hereby declares the whole product including parts (cables, cords, and so on) meets the requirements of RoHS Directive 2011/65/EU and amendment Commission Delegated Directive (EU) 2015/863 on the restriction of the use of certain hazardous substances in electrical and electronic equipment ("RoHS recast" or "RoHS 2.0").

### Radio Equipment Directive

Navimow B.V. hereby declares that the product listed in this section comply with the essential requirements and other relevant provisions of the Radio Equipment Directive 2014/53/EU.

### Machinery Directive

Navimow B.V. hereby declares that the product listed in this section comply with the essential requirements and other relevant provisions of the Machinery Directive 2006/42/EC.

### Europe Authorised Representative:



AR Experts B.V., P.O. Box 5047, 3620 AA Breukelen, The Netherlands

Navimow B.V. hereby declares that the product comply with the essential requirements and other relevant provisions of the RoHS Directive 2011/65/EU and amendment Commission Delegated Directive (EU) 2015/863, the Radio Equipment Directive 2014/53/EU and the Machinery Directive 2006/42/EC.

Bluetooth	Frequency Band(s)	2.4000-2.4835GHz
	Max. RF Power	20mW

# UK Compliance Statement

## Information on Disposal for Users of Waste Electrical & Electronic Equipment



This symbol on the product or on its packaging indicates that used electrical and electronic products should not be mixed with unsorted municipal waste. For proper treatment, it is your responsibility to dispose of your waste equipment by arranging to return it to designated collection points.

Disposing of this product correctly will help save valuable resources and prevent any potential negative effects on human health and the environment, which could otherwise arise from inappropriate waste handling.

To return your used device, please use the return and collection systems or contact the retailer where the product was purchased, which is free of charge, please contact your local authority for further details of your nearest designated collection point.

Penalties may be applicable for incorrect disposal of this waste, in accordance with your national legislation.

## Information on Disposal for Users of used batteries



This symbol means that batteries and accumulators, at their end-of-life, should not be mixed with unsorted municipal waste. Your participation is an important part of the effort to minimize the impact of batteries and accumulators on the environment and on human health. For proper recycling you can return this product or the batteries or accumulators it contains to your supplier or to a designated collection point, which is free of charge.

Disposing of this product correctly will help save valuable resources and prevent any potential negative effects on human health and the environment, which could otherwise arise from inappropriate waste handling.

Penalties may be applicable for incorrect disposal of this waste, in accordance with your national legislation.

there are separate collection systems for used batteries and accumulators.

Please, dispose of batteries and accumulators correctly at your local community waste collection/recycling center.

## The Restriction of the Use of Certain Hazardous Substances in Electrical and Electronic Equipment Regulations 2012

Navimow B.V. hereby declares the whole product including parts (cables, cords, and so on) meets the requirements of The Restriction of the Use of Certain Hazardous Substances in Electrical and Electronic Equipment Regulations 2012.

## Radio Equipment Regulations 2017

Navimow B.V. hereby declares that the product listed in this section comply with the essential requirements and other relevant provisions of Radio Equipment Regulations 2017.

## Supply of Machinery (Safety) Regulations 2008

Navimow B.V. hereby declares that the product listed in this section comply with the essential requirements and other relevant provisions of The Safety of Supply of Machinery (Safety) Regulations 2008.

Navimow B.V. hereby declares that the product comply with the essential requirements and other relevant provisions of the Restriction of the Use of Certain Hazardous Substances in Electrical and Electronic Equipment Regulations 2012, the Radio Equipment Regulations 2017 and the Supply of Machinery (Safety) Regulations 2008.

The declaration of conformity can be viewed at the following address: <https://navimow.segway.com/HelpCenter>

Bluetooth	Frequency Band(s)	2.4000-2.4835GHz
	Max. RF Power	20mW

## 6.4 Contact Us

Manufacturer: Navimow B.V.

Address: Dynamostraat 7, 1014 BN Amsterdam, The Netherlands

Contact us if you experience issues relating to the operation, maintenance and safety, or errors/faults with your mower.

Email: [support-navimow@rlm.segway.com](mailto:support-navimow@rlm.segway.com)

Europe Authorised representative: AR Experts B.V., P.O. Box 5047, 3620 AA Breukelen, The Netherlands

Website: [navimow.segway.com](http://navimow.segway.com)

The manufacturer reserves the right to make changes to the product, release firmware updates, and update this manual at any time. Illustrations of the product, accessories, and app interface in the User Manual are for reference purposes only. Actual product and functions may vary. Go to [navimow.segway.com](http://navimow.segway.com) for the latest user materials.