

Nådendal 155

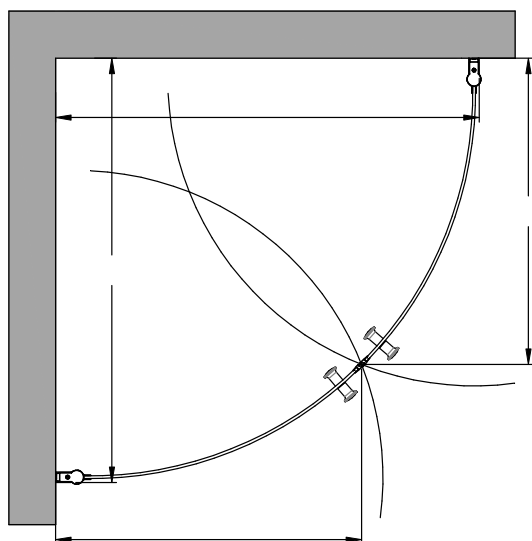

8/25 7FRLM

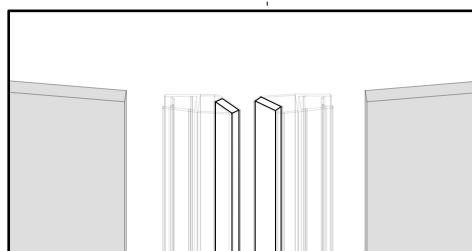
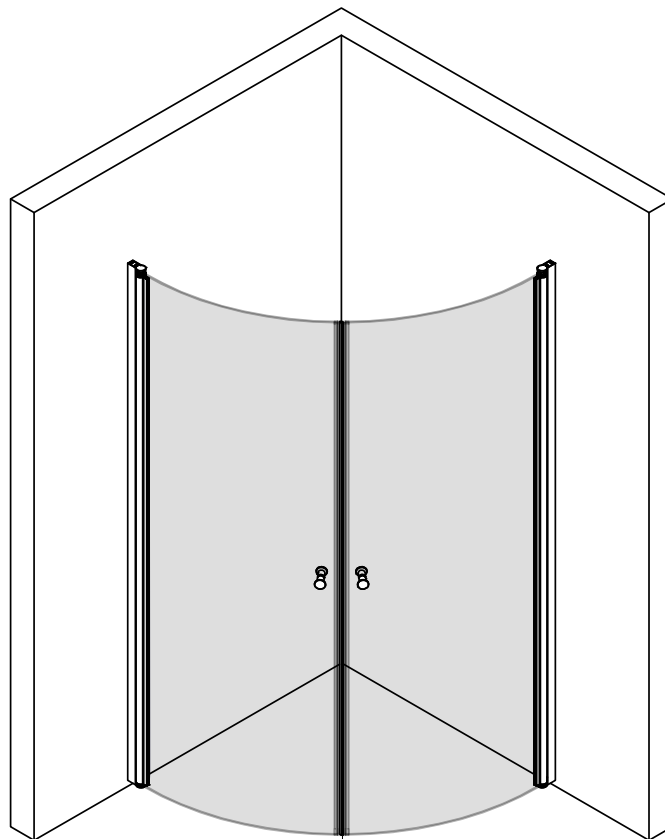

A = 576 / 653

B = 576 / 653

L1 = 800 / 905

L2 = 800 / 905



Nådendal

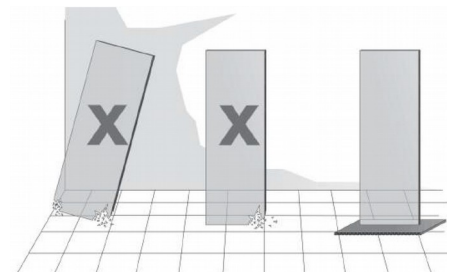
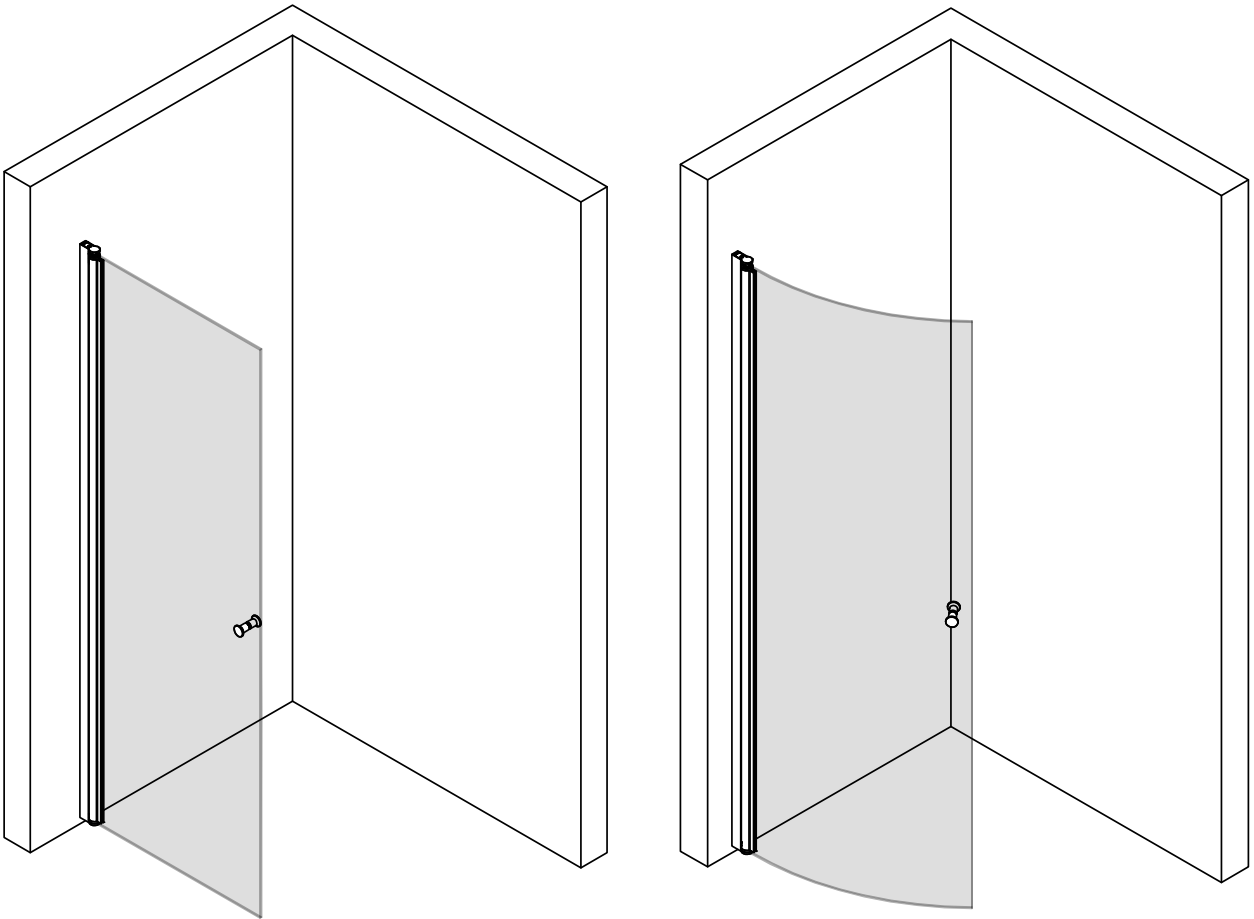

Parts

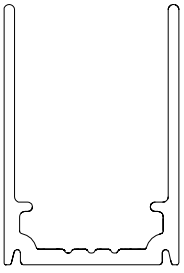

1. x1

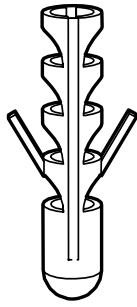

2. 6x30 mm
x4

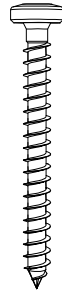

3. 4.5x44 mm
x4

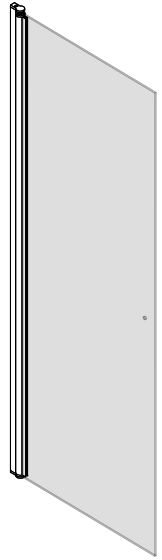

4. x1



5. 4.2x13 mm
x4

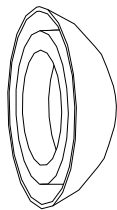

6. x4

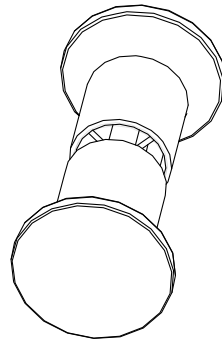

7. x1

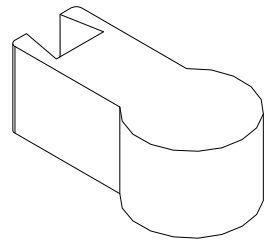

8. x1

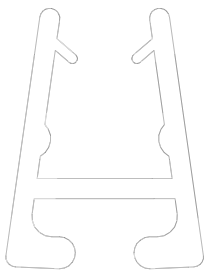

9. x1

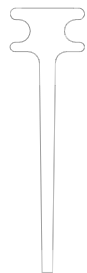

10. x1

Tools

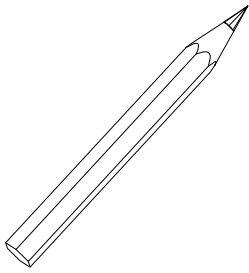

A

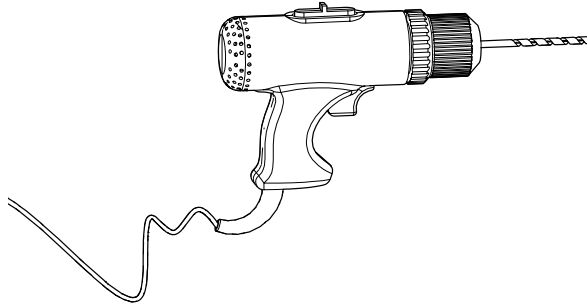

Ø5 mm
Ø6 mm
B

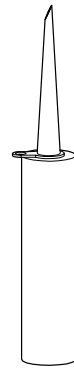

C – Silicone

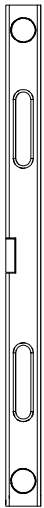

D

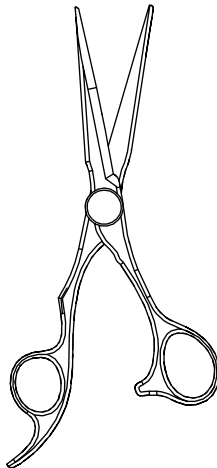

E

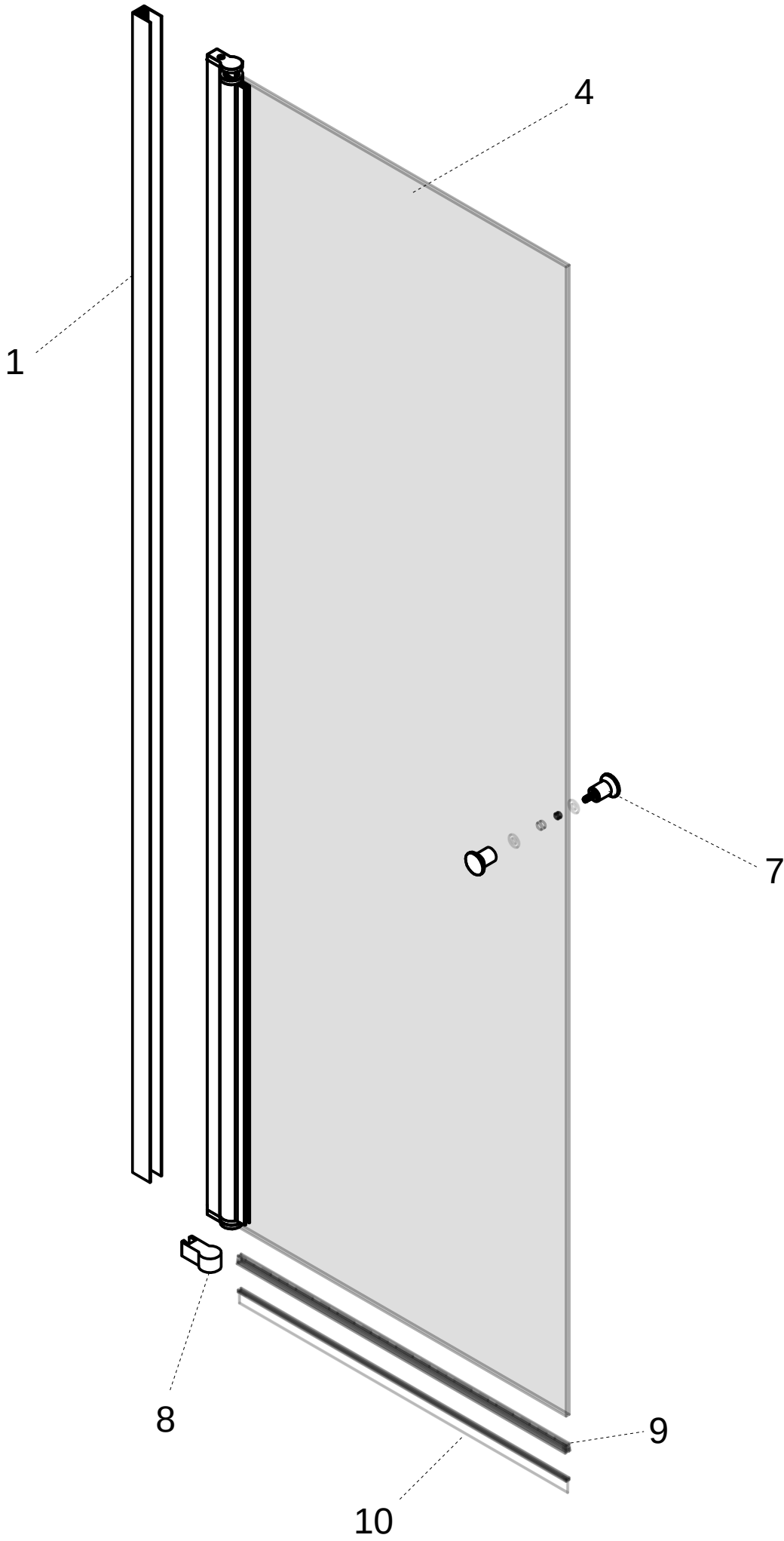

1

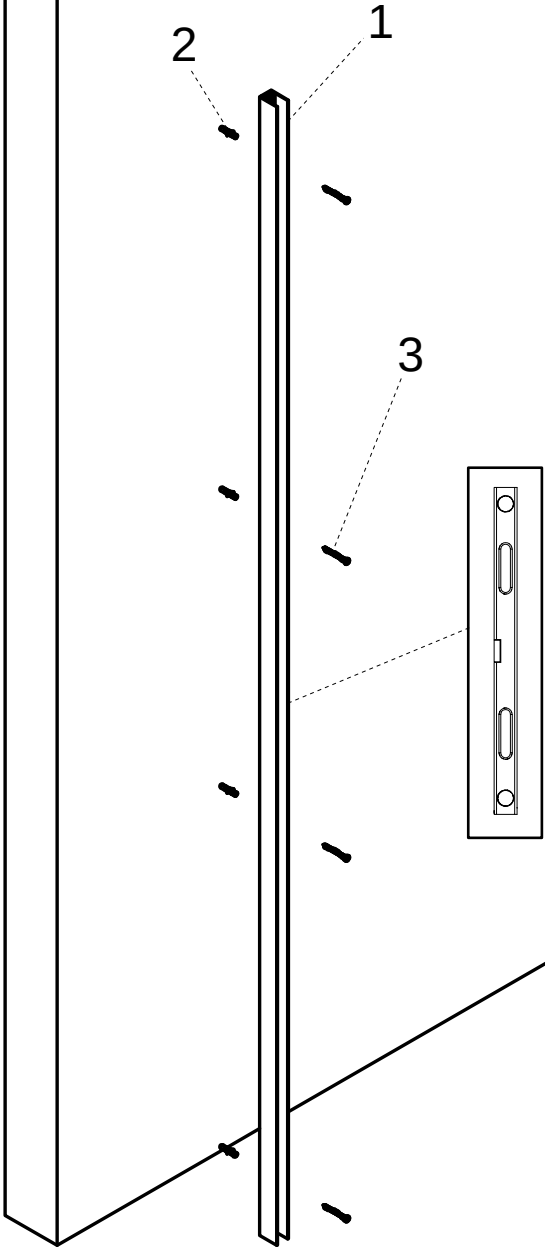
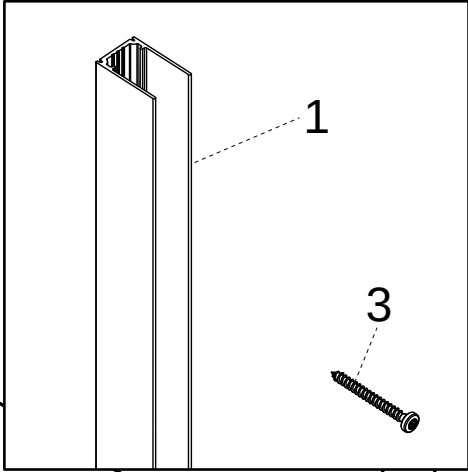
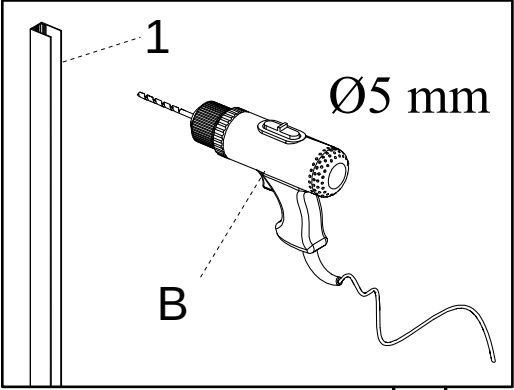
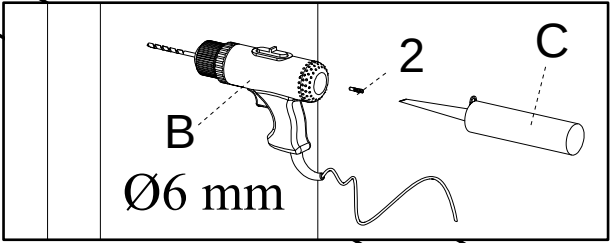

2

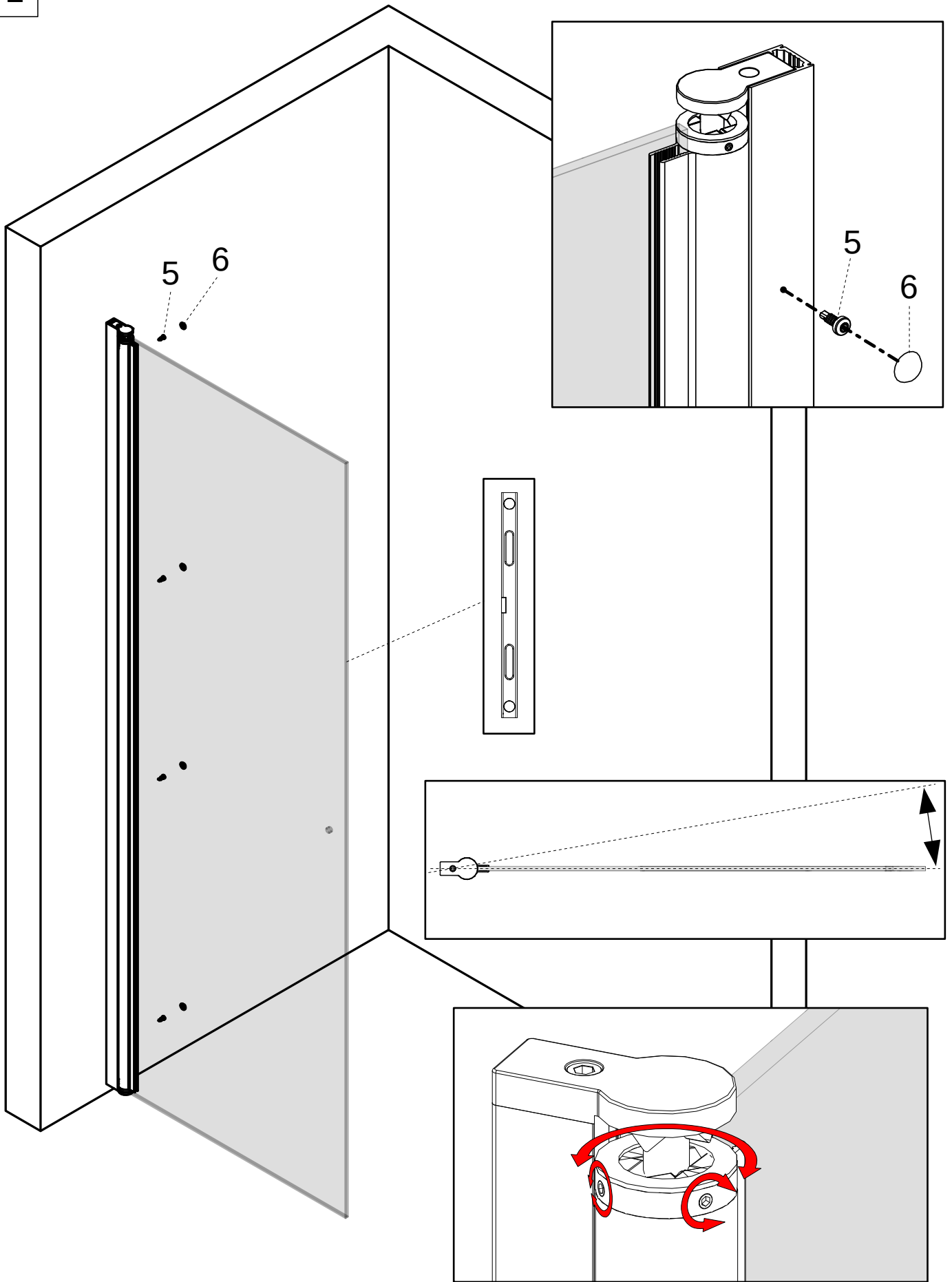

3

