



# DESIGNLIGHT

SCANDINAVIAN AB

## DOWNLIGHT

E-NR: 74 683 00

ART NR: DB-239MW

EFFEKT POWER	MATERIAL MATERIAL	KELVIN KELVIN	ARMATURFÄRG ARMATURE COLOR	ANSLUTNING CONNECTION	TOTAL LUMEN	USEFUL LUMEN
4,8W WITH DRIVER	ALUMINIUM	3000K	MATT WHITE	230V	400LM	384LM

CE, ROHS, IP CERTIFIED BY SGS  

**350MA LED 1x3,2W LIGHT SOURCE WATT**

**LIFETIME L70B50: 50.000H**

**965 CD**

**CRI: >80**

**36°**

**FLICKER FREE**

**IP20 IP44**

**58MM**

**H 37 MM**

**95MM**

• **MULTIFUNKTION GÖR LAMPAN RIKTBAR ÅT ALLA HÅLL**

• **ANPASSAD FÖR MONTERING I BIG-BOX ELLER TAKDOSA**

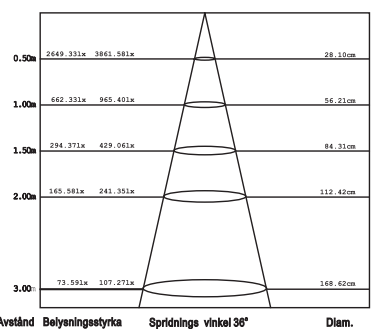
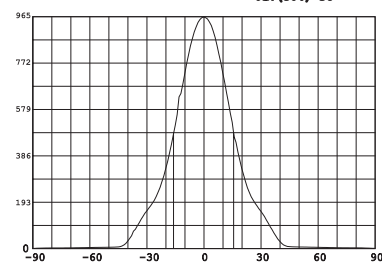
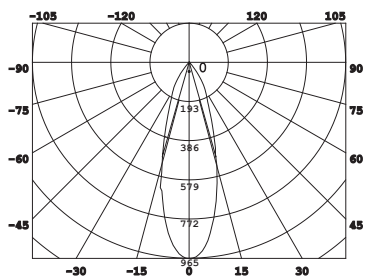

### 1. Stäng av strömmen/Turn off the power

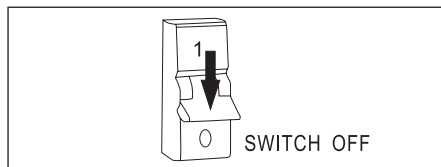

### 2. Borra hål i taket/Drill hole in ceiling

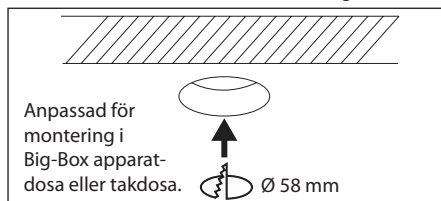

### 3. Anslut till LED-drivern/Connect to LED driver

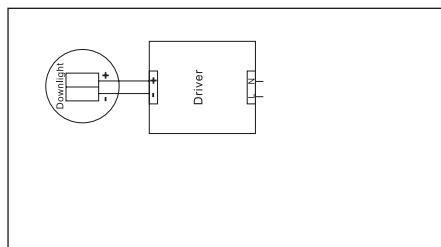

### Mått/Dimension

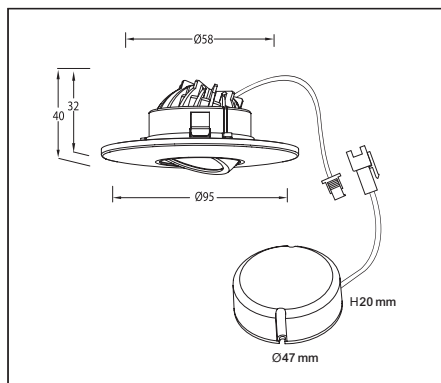

**PRODUKTEN INNEHÅLLER LJUSKÄLLA MED ENERGIMÄRKNING KLASS E.**

### ⚠ SÄKERHET:

- Läs igenom hela manualen noggrant före installation.
- Kontrollmät ALLTID diametern före håltagning i tak.
- Förstärka dig om att spänningen är fränslagen före installation eller underhåll.
- Installation ska utföras av behörig elektriker.
- Ljuskällan är ej utbytbar. Hela armaturen måste bytas när ljuskällan är förbrukad.

### ⚠ SAFETY:

- Read the entire manual carefully before installation.
- ALWAYS check the diameter before drilling holes in the ceiling.
- Make sure that the voltage is switched off before installation or maintenance.
- Installation must be performed by a qualified electrician.
- The light source of this luminaire is not replaceable; when the light source reaches its end of life the whole luminaire shall be replaced.

1.900K	2.700-3.000K	4.000-4.500K	4.800K	5.000-5.000K	7.000-7.500K	10.000K
STEARINLJUS CANDLE	VARMVIT WARM WHITE	NATURLIG VIT NATURAL WHITE	SOLLJUS DIRECT SUN	VITT DAGSLJUS DAY WHITE	KALLVIT COOL WHITE	BLÅ HIMMEL BLUE SKY

**DESIGNLIGHT**  
SCANDINAVIAN AB

DESIGNLIGHT SCANDINAVIAN AB · TOFFELVÄGEN 1 · 342 60 MOHEDA  
KUNDCENTER: TELEFON 0472-716 10 · FAX 0472-716 09 · INFO@DESIGNLIGHT.NU · WWW.DESIGNLIGHT.NU