

Assembly Instruction

MONTERINGSANVISNING | MONTAGEANLEITUNGEN

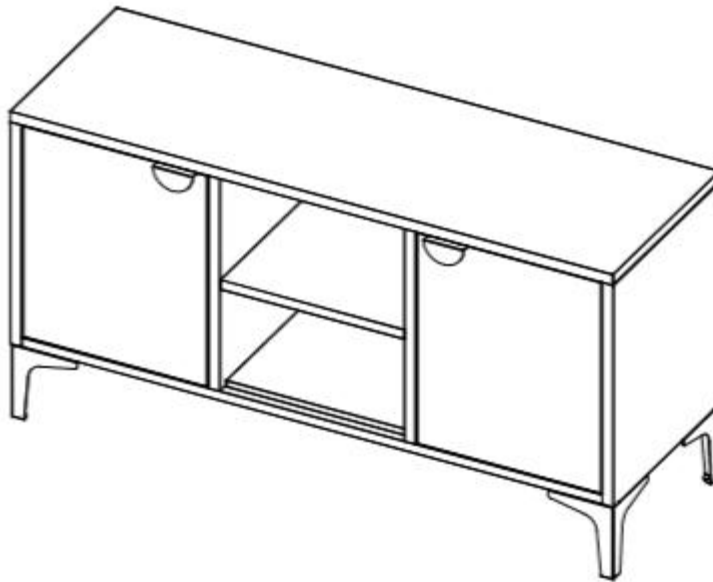

ProductNumber: 15618

Description: Piring TV Stand



@Venturehomese
@Venture.Design

Do not tighten screws until all screws
have been assembled !

Venture
home





Grattis till din nya möbel från Venture Home!

Vi hoppas du ska trivas med din nya möbel!

För att du ska få ut så många år som möjligt av produkten finns några tips och trix för att underhålla den på bästa vis.

Möbler med MDF-skiva / målade möbler

Var aktsam för skav! Då skivan är målad / lackad är det lätt att ytan blir kantstött, var därför aktsam med vassa / hårda delar mot dessa delar. Repor i en målad skiva kan lätt uppstå, var därför noggrann med användning av tallriksunderlägg / duk på bord som är målade.

Våra möbler är handmålade och därför kan färgskiftningar uppkomma och det är mycket svårt att få ytan exakt. Det är därför ingen reklamation om produkten har små skiftningar/ojämnheter i färgen.

Tyg / skinnimitation

Torkas av med lätt fuktad trasa om fläckar uppstår.

Även detta material kan vara känsligt för vassa föremål, var aktsam för repor.

Metalldelar

Kan även dessa vara känsliga för stötar/slag och bör hanteras varsamt för att undvika skador i ytskiktet.

Marmor

Är en porös sten med naturliga färgskiftningar och olika hårdhet över ytan. Stenen är speciellt känslig för sura vätskor varför vanliga rengöringsmedel kan skada ytan. För att skydda ytan bör den behandlas med medel speciellt avsedda för marmor. Alternativt grönsåpa.

Montering

Var aktsam vid montering av produkterna. Om skruvarna dras för hårt (eller med skruvdragare) kan skador i bordsskivan uppstå. Efterdra skruvarna efter en tids användning. Vid montering skall alla skruvar skruvas till 20% innan de sedan korsdras tills de är helt åtskruvade.

Har du frågor ang. din nya möbel, kontakta din ÅTERFÖRSÄLJARE.

Fler Skötselråd hittar du på www.venturehome.se

OBS!

Please be careful when assembling, if screws are tightened too hard (or by screwdriver), damages in the tabletop may appear. Tighten the screws after some time of using the product.





Herzlichen Glückwunsch zu Ihren neuen Möbeln von Venture Home.
Wir hoffen, Sie werden mit Ihren neuen Möbeln zufrieden sein,
Um das Beste aus diesen Produkten herauszuholen, gibt es einige Tipps, wie Sie die
verschiedenen Materialien optimal pflegen können.

Möbel Mit MDF-Platte (lackiert, laminiert, Furnier oder Papier bezogen)
Seien Sie vorsichtig mit scharfen Gegenständen, da diese die Oberfläche und die Kanten
zerkratzen können. Reinigen Sie die Oberfläche mit einem feuchten Tuch. Übermäßige
Flüssigkeiten können Blasen in der Oberfläche verursachen.

Einige unserer Möbel sind handbemalt, daher sind Farbunterschiede / kleine Kratzer auf der
Oberfläche kein Anspruch.

Stoffe / PU / Samt

Stellen Sie die Stellen mit einem feuchten Tuch ab. Insbesondere Samt- und PU-Stoffe sind
empfindlich gegen scharfe Gegenstände.

Metall

Vorsichtig behandeln, um die Oberfläche nicht zu belasten. Mit einem Staubtuch reinigen.

Teppiche

Auf der Rückseite Ihres Teppichs finden Sie spezifische Anweisungen für Ihren Teppich.

Unbehandeltes Holz

Entfernen Sie Flecken mit einem feuchten Tuch. Zum Schutz der Oberfläche kann ein klares
Teakwachs verwendet werden. Beachten Sie, dass dies dem Tisch ein glänzendes Finish
verleiht. Verschüttetes sofort beseitigen.

Marmor:

ist empfindlich gegenüber sauren Flüssigkeiten, weshalb die meisten
Standardreinigungsmittel nicht für Marmor geeignet sind. Verwenden Sie zum Schutz Ihrer
Marmoroberfläche weiche Seife oder Schutzlack, der speziell für Marmor hergestellt wurde.
Diese Lacke finden Sie normalerweise in Ihrem örtlichen Baumarkt oder Möbelgeschäft.

Hinweis!

Seien Sie beim Zusammenbau vorsichtig. Wenn die Schrauben zu fest angezogen werden
(oder mit einem Schraubendreher), können Schäden an der Tischplatte auftreten. Wenn
diese Schäden bei der Montage auftreten, betrachten wir dies nicht als Anspruch!
Ziehen Sie alle Schrauben 20% an, bevor Sie alle Schrauben fest anziehen, bis alle Schrauben
fest angezogen sind.

Möglicherweise müssen die Schrauben nach einiger Zeit des Gebrauchs des Produkts
festgezogen werden..

Weitere Pflegehinweise finden Sie unter www.venturehome.se





Congratulations on your new furniture from Venture Home,

We hope you will be happy with your new furniture,
In order to get the most of this products there are some tips on how to care for the different materials in the best way.

Furniture With MDF-top (painted, laminated, veneer or paper covered)
Be careful with sharp objects as they may scratch the surface and edges. Clean the surface with damp cloth . Excessive fluids may cause bubbles in the surface.

Some of our furniture are hand painted, hence differences in coloration / small scratches over the surface is not a claim.

Fabrics / PU / Velvet
Wipe with damp cloth on spots. Especially Velvet and PU-fabrics are sensitive for sharp objects.

Metal
Handle with care in order to not cause distress to the surface. Clean with dust cloth.

Carpets
On the backside of your carpet you can find specific instruction for your rug.

Untreated Wood
Use damp cloth to remove stains. For protection of the surface a clear teak wax can be used. Note that this will give the table a shiny finish. Clean up any spill immediately.







Marble:
is sensitive to acidic liquids, which makes most standard cleaning detergents not applicable to marble. In order to protect your marble surface – use soft soap or protective varnish especially made for marble. These varnishes can usually be found at your local hardware store or furniture shop.

For more care advise, see www.venturehome.se

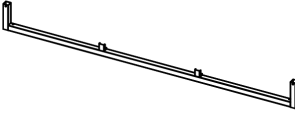
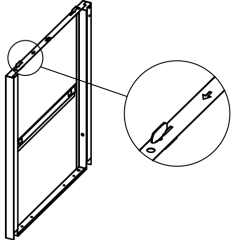
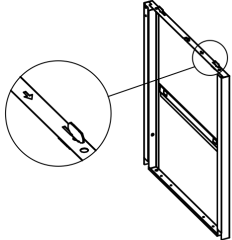
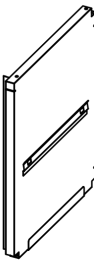
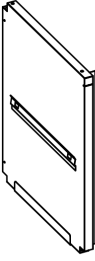
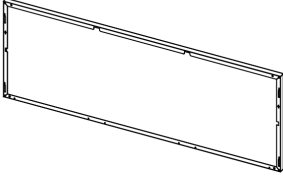
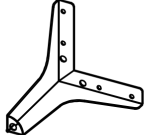
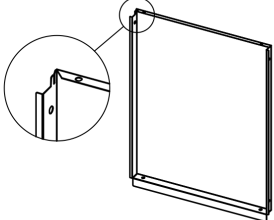
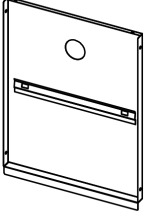
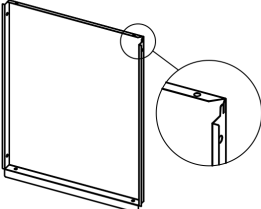
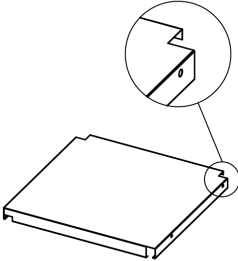
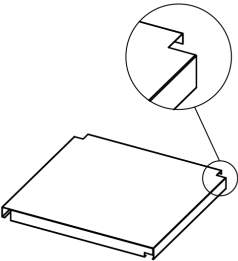
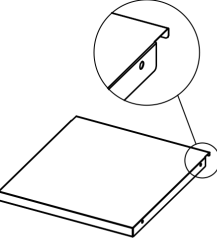
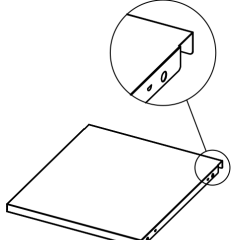
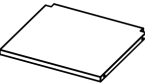
Note!
Be careful when assembling, if screws are tightened too hard (or by screwdriver), damages in the tabletop may appear. If these damages appear in assembly, we do not consider this a claim!
Tighten all screws 20% before cross-tighten all screws until all screws are fully tightened.

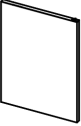
Screws might need to be tightened after some time of using the product.

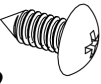

<p>A</p>  <p>×2</p>	<p>B</p>  <p>×1</p>	<p>C</p>  <p>×1</p>	<p>D</p>  <p>×1</p>
<p>E</p>  <p>×1</p>	<p>F</p>  <p>×1</p>	<p>G</p>  <p>×4</p>	<p>H</p>  <p>×1</p>
<p>I</p>  <p>×1</p>	<p>J</p>  <p>×1</p>	<p>K</p>  <p>×1</p>	<p>L</p>  <p>×1</p>
<p>M</p>  <p>×1</p>	<p>N</p>  <p>×1</p>	<p>O</p>  <p>×2</p>	<p>P</p>  <p>×1</p>
<p>Q</p>  <p>×1</p>	<p>R</p>  <p>×2</p>	<p>a</p>  <p>×2</p>	<p>b</p>  <p>M5 × 12 × 36</p>
		<p>c</p>  <p>×6</p>	<p>d</p>  <p>×4</p>

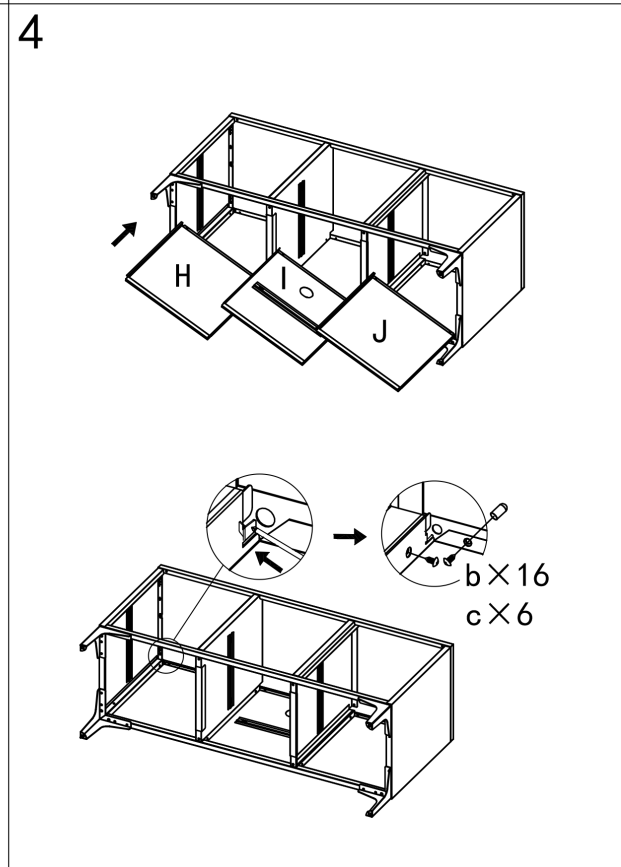
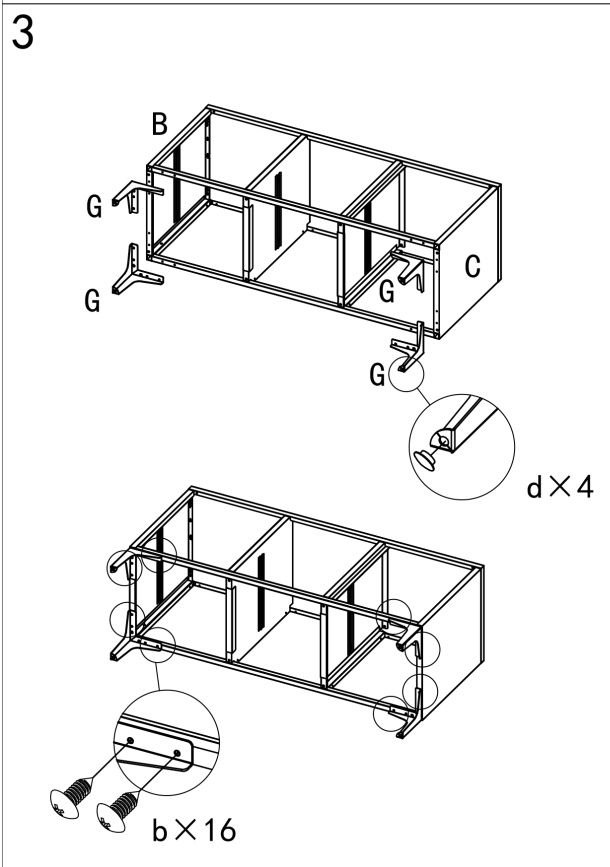
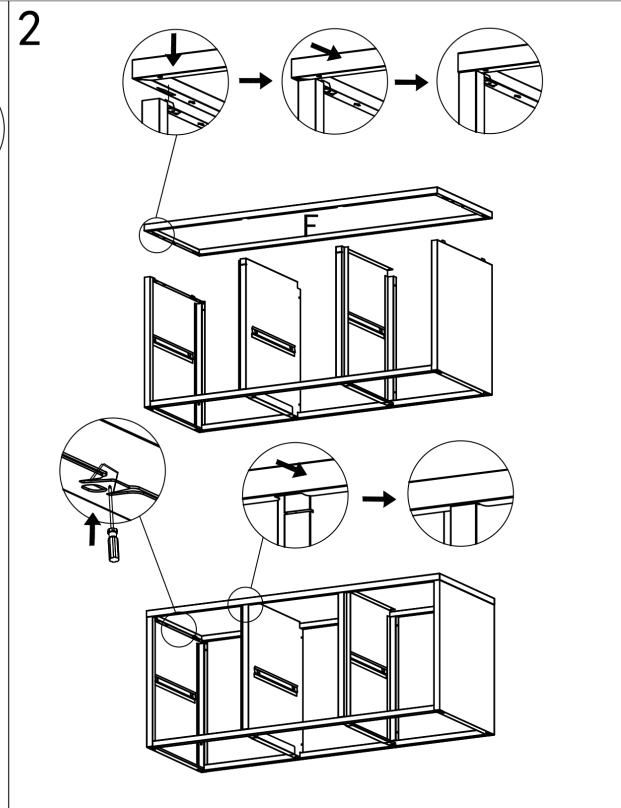
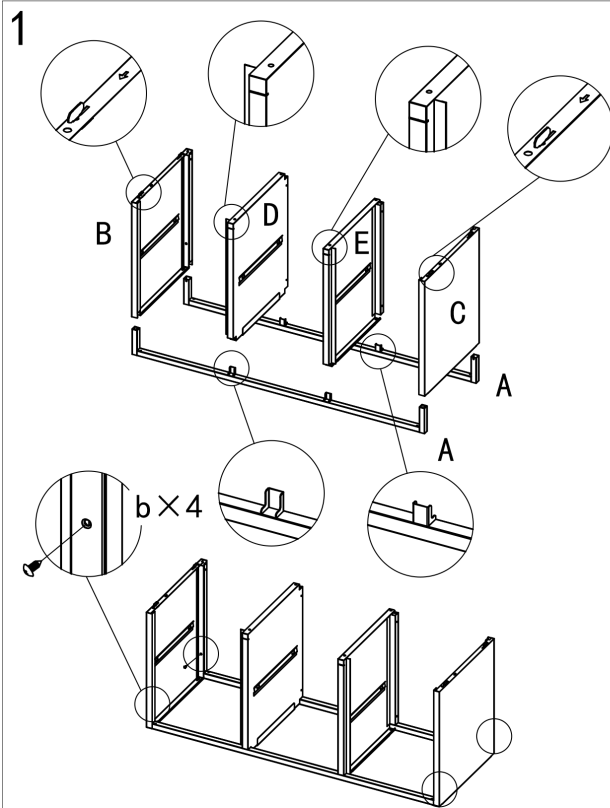

5

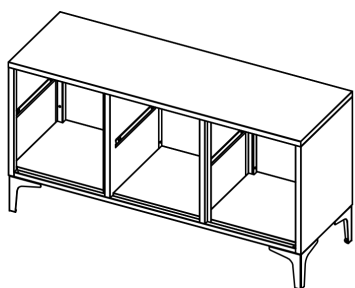
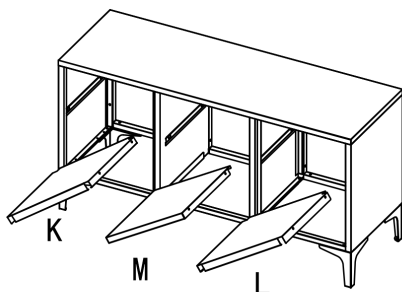

6

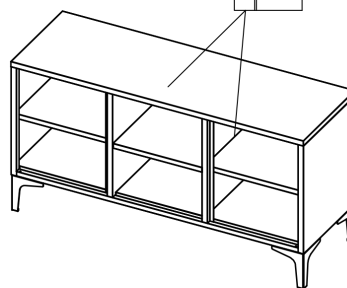
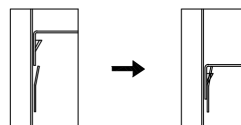
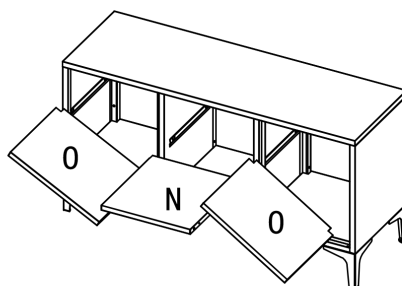

7

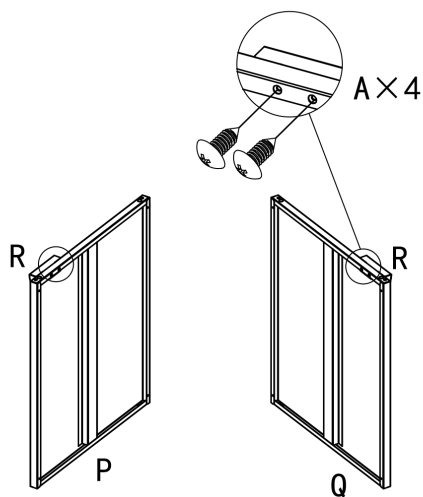

8

