

RUPES[®]

HR81M
HR81ML
Polishers

INSTRUCTION MANUAL (Original version)



! WARNING

For your personal safety, READ and UNDERSTAND the instruction manual before using.

Explanation of Signal Word



WARNING: Indicates a potentially hazardous situation, which, if not avoided, could result in **death or serious injury and/or property damage.**



CAUTION: Indicates a potentially hazardous situation, which, if not avoided, may result in **minor or moderate injury and/or property damage.**

NOTICE: Indicates a potentially hazardous situation, which, if not avoided, may result in **property damage.**

General Power Tool Safety Warnings



WARNING Read all safety warnings and instructions. Failure to follow the warnings and instructions may result in electric shock, fire and/or serious injury.

Save all warnings and instructions for future reference.

The term power tool in the warnings refers to your mains-operated (corded) power tool or battery-operated (cordless) power tool.

1) Work area safety

- a) **Keep work area clean and well lit.** Cluttered or dark areas invite accidents.
- b) **Do not operate power tools in explosive atmospheres, such as in the presence of flammable liquids, gases or dust.** Power tools create sparks which may ignite the dust or fumes.
- c) **Keep children and bystanders away while operating a power tool.** Distractions can cause you to lose control.

2) Electrical safety

- a) **Power tool plugs must match the outlet. Never modify the plug in any way. Do not use any adapter plugs with earthed (grounded) power tools.** Unmodified plugs and matching outlets will reduce risk of electric shock.
- b) **Avoid body contact with earthed or grounded surfaces such as pipes, radiators, ranges and refrigerators.** There is an increased risk of electric shock if your body is earthed or grounded.
- c) **Do not expose power tools to rain or wet conditions.** Water entering a power tool will increase the risk of electric shock.
- d) **Do not abuse the cord. Never use the cord for carrying, pulling or unplugging the power tool. Keep cord away from heat, oil, sharp edges or moving parts.** Damaged or entangled cords increase the risk of electric shock.
- e) **When operating a power tool outdoors, use an extension cord suitable for outdoor use.** Use of a cord suitable for outdoor use reduces the risk of electric shock.
- f) **If operating a power tool in a damp location is unavoidable, use a residual current device (RCD) protected supply.** Use of an RCD reduces the risk of electric shock.

3) Personal safety

- a) **Stay alert, watch what you are doing and use common sense when operating a power tool. Do not use a power tool while you are tired or under the influence of drugs, alcohol or medication.** A moment of inattention while operating power tools may result in serious personal injury.

b) **Use personal protective equipment. Always wear eye protection.** Protective equipment such as dust mask, non-skid safety shoes, hard hat, or hearing protection used for appropriate conditions will reduce personal injuries.

c) **Prevent unintentional starting. Ensure the switch is in the off-position before connecting to power source and/or battery pack, picking up or carrying the tool.**

Carrying power tools with your finger on the switch or energising power tools that have the switch on invites accidents.

d) **Remove any adjusting key or wrench before turning the power tool on.** A wrench or a key left attached to a rotating part of the power tool may result in personal injury.

e) **Do not overreach. Keep proper footing and balance at all times.** This enables better control of the power tool in unexpected situations.

f) **Dress properly. Do not wear loose clothing or jewellery. Keep your hair, clothing and gloves away from moving parts.** Loose clothes, jewellery or long hair can be caught in moving parts.

g) **If devices are provided for the connection of dust extraction and collection facilities, ensure these are connected and properly used.** Use of dust collection can reduce dust-related hazards.

4) **Power tool (provided or optional) use and care**

a) **Do not force the power tool. Use the correct power tool for your application.** The correct power tool will do the job better and safer at the rate for which it was designed.

b) **Do not use the power tool if the switch does not turn it on and off.** Any power tool that cannot be controlled with the switch is dangerous and must be repaired.

c) **Disconnect the plug from the power source and/or the battery pack from the power tool before making any adjustments, changing accessories, or storing power tools.**

Such preventive safety measures reduce the risk of starting the power tool accidentally.

d) **Store idle power tools out of the reach of children and do not allow persons unfamiliar with the power tool or these instructions to operate the power tool.** Power tools are dangerous in the hands of untrained users.

e) **Maintain power tools. Check for misalignment or binding of moving parts, breakage of parts and any other condition that may affect the power tool's operation. If damaged, have the power tool repaired before use.** Many accidents are caused by poorly maintained power tools.

f) **Keep cutting tools sharp and clean.** Properly maintained cutting tools with sharp cutting edges are less likely to bind and are easier to control.

g) **Use the power tool, accessories and tool bits etc. in accordance with these instructions, taking into account the working conditions and the work to be performed.**

Use of the power tool for operations different from those intended could result in a hazardous situation.

5) **Battery Tool (provided or optional) Use and Care**

a. **Recharge only with the charger specified by the manufacturer.** A charger that is suitable for one type of battery pack may create a risk of fire when used with another battery pack.

b. **Use power tools only with specifically designated battery packs.** Use of any other battery packs may create a risk of injury and fire.

c. **When battery pack is not in use, keep it away from other metal objects, like paper clips, coins, keys, nails, screws or other small metal objects, that can make a connection from one terminal to another.** Shorting the battery terminals together may cause burns or a fire.

- d. **Under abusive conditions, liquid may be ejected from the battery; avoid contact. If contact accidentally occurs, flush with water. If liquid contacts eyes, additionally seek medical help.** Liquid ejected from the battery may cause irritation or burns.

6) Service

- a) **Have your power tool serviced by a qualified repair person using only identical replacement parts.** This will ensure that the safety of the power tool is maintained.

Additional Safety Instructions

1. **This tool is designed to be used as a polisher. Read all the warnings, instructions, indications provided on drawings and specifications supplied with this tool.** Failure to comply with all the instructions provided below may cause electrical shocks, fire and/or serious injuries.
2. **The tool must be used with accessories that have been specifically designed or recommended by the manufacturer.** The fixing of the accessory to the tool does not guarantee a safe operation.
3. **The rated speed of the accessories must be at least equivalent to the maximum speed specified on the tool.** Using the accessories at speeds above the rated one, may cause them to break or be projected into the air.
4. **The external diameter and thickness of the accessories must match the specifications of the tool.** Accessories with incorrect dimensions cannot be adequately protected or controlled.
5. **The configuration of accessories must match the tool.** The use of accessories that cannot be perfectly fitted on the tool may result in imbalance, excessive vibrations and in the impossibility of controlling the tool.
6. **Do not use damaged accessories. Before use, inspect all the accessories. Inspect the supporting pads and verify there are no cracks, tears or excessive wear. If the tool or accessory has fallen, verify that it is not damaged or install a new accessory. After inspecting or installing an accessory, test the operation of the tool at maximum speed and without load for one minute, keeping at a safety distance.** If the accessories are damaged, they will break during this test.
7. **Wear personal protective equipment. Depending on application, use face shield, safety goggles or safety glasses. As appropriate, wear dust mask, hearing protectors, gloves and workshop apron capable of stopping small abrasive or workpiece fragments. The eye protection must be capable of stopping flying debris generated by various operations.** The dust mask or respirator must be capable of filtrating particles generated by your operation. Prolonged exposure to high intensity noise may cause hearing loss.
8. **Keep bystanders a safe distance away from work area. Anyone entering the work area must wear personal protective equipment.** Fragments of workpiece or of a broken accessory may fly away and cause injury beyond immediate area of operation.
9. **Hold power tool by insulated surfaces only, when performing an operation where the cutting accessory may contact hidden wiring or its own cord.** Cutting accessory contacting a "live" wire may make exposed metal parts of the power tool "live" and shock the operator.

10. **Position the cord clear of the spinning accessory.** If you lose control, the cord may be cut or snagged and your hand or arm may be pulled into the spinning accessory.
11. **Never lay the power tool down until the accessory has come to a complete stop.** The spinning accessory may grab the surface and pull the power tool out of your control.
12. **Do not run the power tool while carrying it at your side.** Accidental contact with the spinning accessory could snag your clothing, pulling the accessory into your body.
13. **Regularly clean the power tool's air vents.** The motor's fan will draw the dust inside the housing and excessive accumulation of powdered metal may cause electrical hazards.
14. **Do not operate the power tool near flammable materials.** Sparks could ignite these materials.
15. **Do not use accessories that require liquid coolants.** Using water or other liquid coolants may result in electrocution or shock.

Further Safety Instructions for All Operations

KICKBACK AND RELATED WARNINGS

Kickback is a sudden reaction to a pinched or snagged rotating wheel, backing pad, brush or any other accessory. Pinching or snagging causes rapid stalling of the rotating accessory which in turn causes the uncontrolled power tool to be forced in the direction opposite of the accessory's rotation at the point of the binding.

For example, if an abrasive wheel is snagged or pinched by the workpiece, the edge of the wheel that is entering into the pinch point can dig into the surface of the material causing the wheel to climb out or kick out. The wheel may either jump toward or away from the operator, depending on direction of the wheel's movement at the point of pinching. Abrasive wheels may also break under these conditions.

Kickback is the result of tool misuse and/or incorrect operating procedures or conditions and can be avoided by taking proper precautions as given below:

- 1) **Maintain a firm grip on the power tool and position your body and arm to allow you to resist kickback forces.** The operator can control torque reaction or kickback forces, if proper precautions are taken.
- 2) **Never place your hand near the rotating accessory.** Accessory may kickback over your hand.
- 3) **Do not position your body in the area where power tool will move if kickback occurs.** Kickback will propel the tool in direction opposite to the wheel's movement at the point of snagging.
- 4) **Use special care when working corners, sharp edges, etc. Avoid bouncing and snagging the accessory.** Corners, sharp edges or bouncing have a tendency to snag the rotating accessory and cause loss of control or kickback.
- 5) **Do not attach a saw chain woodcarving blade or toothed saw blade.** Such blades create frequent kickback and loss of control.

Safety Warnings Specific for Polishing Operations

Do not allow any loose portion of the polishing bonnet or its attachment strings to spin freely. Tuck away or trim any loose attachment strings. Loose and spinning attachment strings can entangle your fingers or snag on the workpiece.

Additional Specific Safety Instructions for Polishers

- **Always use eye protection.** All users and bystanders must wear eye protection that conforms to ANSI Z87.1.
- **Clean out your tool often, especially after heavy use.** Dust and grit containing metal particles often accumulate on interior surfaces and could create an electric shock hazard.
- **Do not operate this tool for long periods of time.** Vibration caused by the operating action of this tool may cause permanent injury to fingers, hands and arms. Use gloves to provide extra cushion, take frequent rest periods and limit daily time of use.
- **Air vents often cover moving parts and should be avoided.** Loose clothes, jewelry or long hair can be caught in moving parts.

 **WARNING: ALWAYS** use safety glasses. Everyday eyeglasses are NOT safety glasses. Also use face or dust mask if cutting operation is dusty. **ALWAYS WEAR CERTIFIED SAFETY EQUIPMENT:**

- ANSI Z87.1 eye protection,
- ANSI S12.6 (S3.19) hearing protection,
- NIOSH/OSHA/MSHA respiratory protection.

 **WARNING: Always wear proper personal hearing protection that conforms to ANSI S12.6 (S3.19) during use.** Under some conditions and duration of use, noise from this product may contribute to hearing loss.

 **WARNING:** Some dust created by power sanding, sawing, grinding, drilling, and other construction activities contains chemicals known to the State of California to cause cancer, birth defects or other reproductive harm. Some examples of these chemicals are:





- lead from lead-based paints,
- crystalline silica from bricks and cement and other masonry products, and
- arsenic and chromium from chemically-treated lumber.

Your risk from these exposures varies, depending on how often you do this type of work. To reduce your exposure to these chemicals: work in a well ventilated area, and work with approved safety equipment, such as those dust masks that are specially designed to filter out microscopic particles.

- **Avoid prolonged contact with dust from power sanding, sawing, grinding, drilling and other construction activities. Wear protective clothing and wash exposed areas with soap and water.** Allowing dust to get into your mouth, eyes, or lay on the skin may promote absorption of harmful chemicals.

 **WARNING:** Use of this tool can generate and/or disperse dust, which may cause serious and permanent respiratory or other injury. Always use NIOSH/OSHA approved respiratory protection appropriate for the dust exposure. Direct particles away from face and body.

 **CAUTION:** Use extra care when working into a corner because a sudden, sharp movement of the polisher may be experienced when the wheel or other accessory contacts a secondary surface or a surface edge.

Summary of device labels containing safety information			
Symbology			
Symbol	Description	Symbol	Description
	WARNING: To reduce the risk of injury, user must read instruction manual	V	Volt
	CE mark for EU market	No	No-load speed
	Direct current	/min	Per minute
	WEEE Compliant		



Save these instructions

PARTS OF THE TOOL WITH A BATTERY PACK

- 1 - Identification plate
- 2 - ON/OFF / speed regulation Knob
- 3 - Buffer pad (not supplied)
- 4 - Velcro faced disc pad
- 5 - Motor ventilation slots
- 6 - Shaft locking button
- 7 - ON/OFF switch lever
- 8 - Battery pack 10,8V cod 9HB120LT
- 9 - Battery level LED
- 10 - Power supply 9HP120LT (optional) (Fig.2)

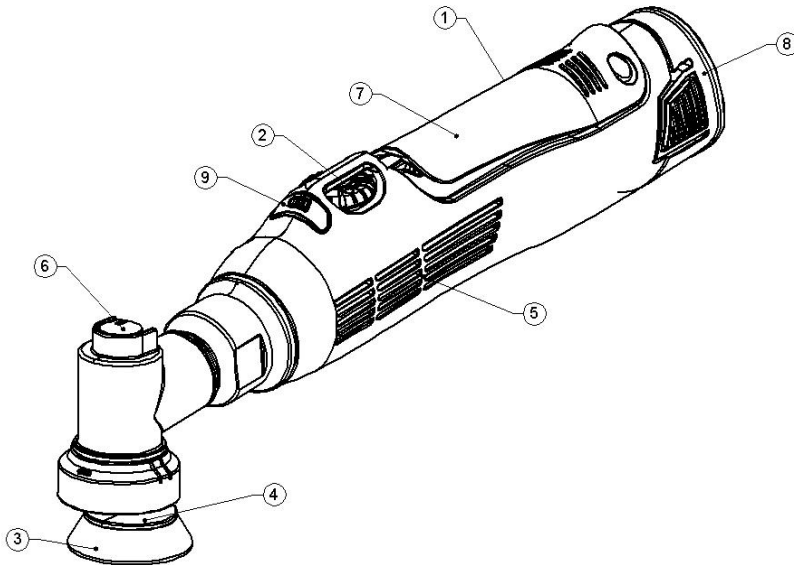

Fig.1

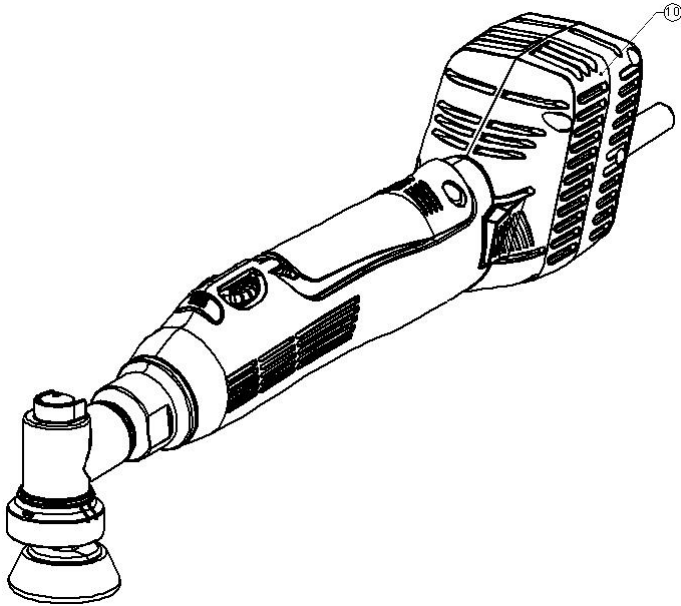

Fig. 2

INTENDED USE

The HR81M and HR81ML dual action polishers are designed for polishing painted or unfinished metal, fiberglass, and composite surfaces in professional applications. Common examples of use include but are not limited to: auto/marine/RV/motorcycle detailing and finish correction, boat construction and repair, and metal or concrete finishing.

Do not use in the presence of flammable liquids or gases. Do not let children come into contact with the tool. Supervision is required when inexperienced operators use this tool.

MOTOR

⚠ WARNING: To reduce the risk of injury, only the 12V Li-ION Battery Pack 9HB120LT or the Power supply 9HP120LT (optional) for the motor supply should be used with this product.

The tool is operated by a 12V DC motor. Since the batteries, other than those offered by Rupes, have not been tested with this product, use of such batteries with this tool could cause the injury and property damage.

SWITCH

 **WARNING:** To reduce the risk of injury, turn the knob (2) until OFF position after any use.

To turn the unit on, rotate the potentiometer knob (2) and set up the speed from 1 to 5 value. Push the switch lever (7) towards the body of the tool.

To turn it off, release the lever and rotate the potentiometer knob until OFF position.

ELECTRONIC CONTROLLER

The main functions of electronic controller are:

- Speed control
- Batteries and motor protection
- Battery pack lever indication
- Soft start

Speed control

The speed of your tool can be changed by rotating the speed regulation knob (2) to the desired setting.

The electronic speed control not only lets you select the speed to suit the job, but also helps to maintain that speed as you load the tool by pressing down.

The speed regulation knob (2) can be set for any speed between 2000 and 5000 RPM.

Batteries and motor protection

The electronic protection protect the motor and batteries from overheating. Also it guarantee a longer life of both.

Battery pack lever indication

The battery level LED show the charge level of the batteries changing the colour:

- GREEN: from 100% to 50% batteries charge
- YELLOW: from 50% to 20% batteries charge
- RED: from 20% to 0% batteries charge
- RED BLINKING: 0% battery charge: the tool does not start.

Soft start

The soft start guarantee the motor and battery protection and reduce the risk of injury for the operator.

OPERATION

 **WARNING:**

- **To reduce the risk of injury, turn unit off and disconnect it from power source before installing and removing accessories, before adjusting or when making repairs.** Be sure the switch is in the "OFF" position. An accidental start-up can cause injury.
- **Never modify any parts of the power tool.** Damage or personal injury could result.
- To reduce the risk of injury, wear safety goggles or glasses.
- Replace the buffer pad (not supplied) regularly. Worn buffer pads are less safe and likely to provide a non-uniform job

- Always wear a properly fitted respirator at all times while working on lead-based paint;
- Always use appropriate respiratory, skin protection and/or local exhaust as stated in the MSDS of the material being worked on
- Never use this tool system in a home environment where young children are present without responsible adult supervision

STARTING UP

Before starting-up the tool ensure that:

- the packaging is complete and does not show signs of having been damaged during storage or transport;
- the tool is complete; check that the number and type of components comply with that reported in this instruction booklet;

ASSEMBLING THE TOOL

⚠ WARNING: Before (dis)assembling the tool assure that the speed regulation Knob (2) is in OFF position

Follow the steps to assemble the unit:

- 1) Push the shaft-locking button (6) (Fig. 3)

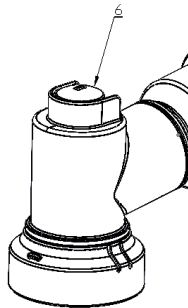

Fig.3

MOUNTING THE COUNTERWEIGHT

⚠ WARNING: Do not force the screw it could break. The maximum allowed screw force is 2Nm. For the screw use only a *clockwise* direction when the tool is positioned as show in a Fig. 4 (for unscrew use counterclockwise direction).

2) Screw the unit on a tool shaft (orbital version). Use a provided key to hold a counterweight (Fig.4).

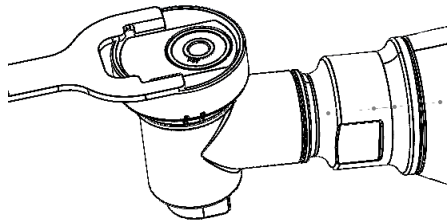

Fig.4

MOUNTING THE DISC PAD

⚠ WARNING: Do not force the screw it could break. The maximum allowed screw force is 2Nm. For the screw use only a *clockwise* direction when the tool is position as show in a Fig. 5 and Fig. 6 (for unscrew use counterclockwise direction)

3.1) Mount the disc pad by screwing it in the red/blue shaft (orbital version Fig.5). Follow the steps:

1. Place the disc pad (4)
2. Screw the disc pad on a shaft (holding it with a provided key)
3. To remove, hold the shaft with a provided key and unscrew the disc pad

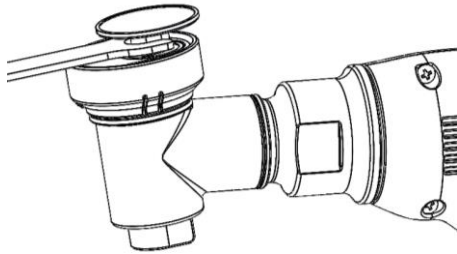

Fig.5

- 3.2) Mount the disc pad by screwing it in a green shaft (rotary version Fig.6). Follow the steps:
1. Place the disc pad (4)
 2. Hold the shaft locking button (6) and screw the disc pad on a shaft (Fig. 7)
 3. To remove, hold the shaft locking button (6) and unscrew the disc pad

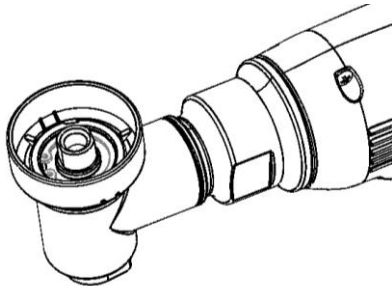

Fig.6

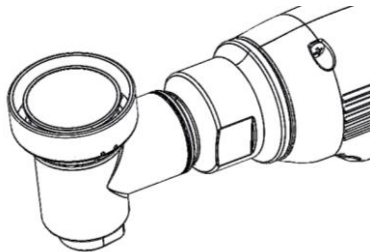

Fig.7

Note:

Red shaft - indicates orbit 12

Blue shaft - indicates orbit 3

Green shaft - indicates rotary version

ASSEMBLING THE BUFFER PAD (Not provided)

△CAUTION: Accessories must be rated for at least the speed recommended on the tool warning label. Accessories running over rated speed can fly apart and cause injury. Accessory ratings must always be above tool speed as shown on tool nameplate.

Assemble the buffer pad (3) (Fig. 8) on the velcro surface of the disc pad (4). Press the buffer pad to attach it to the disc pad.

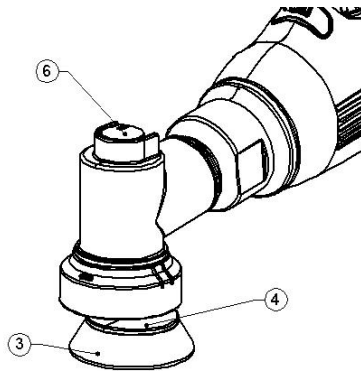

Fig.8

MOUNTING THE BRUSH (provided or optional)

⚠ WARNING: Do not force the screw it could break. The maximum allowed screw force is 2Nm. For the screw use only a clockwise direction when the tool is position as show in a Fig. 9 and Fig. 10 (for unscrew use counterclockwise direction)

- 4) Mount the brush (rotary version) (Fig. 9) by screwing it in a green shaft. Follow the steps:
 1. Place the brush
 2. Hold the shaft-locking button (6) and screw the brush on the green shaft (Fig. 10)
 3. To remove, hold the shaft locking button (6) and unscrew the brush

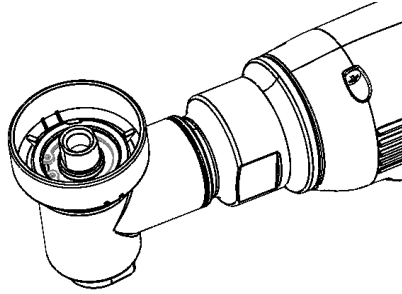

Fig.9

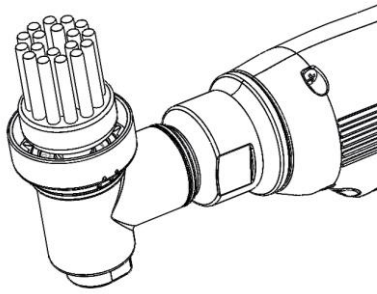

Fig.10

TOOL WITH BATTERY (PROVIDED OR OPTIONAL)

CHARGE THE BATTERY PACK 9HB120LT (8)

The battery pack(s) contained in the kit shall be charged before use. The provided battery is charged about 50%. In order to charge connect the Li-ion battery with a charging station 9HC120LT till the charging is completed.



WARNING

For your personal safety, **READ** and **UNDERSTAND** the instruction manual of charging station 9HC120LT before using.

ASSEMBLE BATTERY PACK 9HB120LT

 **WARNING:** Before (dis)assembling the tool assure that the speed regulation Knob (2) is in **OFF** position.

In order to assemble the battery pack push two clips (Fig. 11) at the same time and insert the battery pack in the tool till it is fixed.

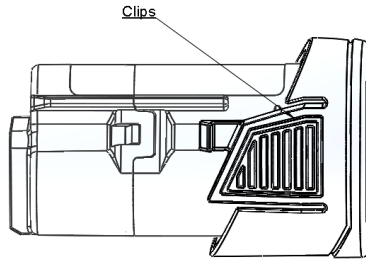

Fig.11

In order to disassemble push two clips at the same time and extract the battery from a tool (Fig.12)

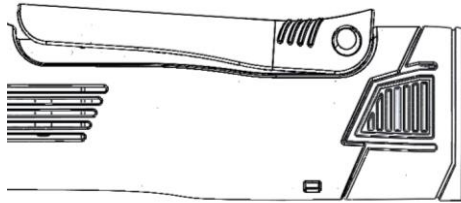

Fig.12

TOOL WITH POWER SUPPLY (PROVIDED OR OPTIONAL)



WARNING

For your personal safety, **READ** and **UNDERSTAND** the instruction manual of Power supply 9HP120LT before using.

ASSEMBLE POWER SUPPLY 9HP120LT (10)



WARNING: Before (dis)assembling the tool assure that the speed regulation Knob (2) is in OFF position.

In order to assemble the power supply block push two clips (Fig.13) at the same time and insert the power supply block in the tool till it is fixed.

In order to disassemble push two clips at the same time and extract the power supply block from a tool (Fig.14)

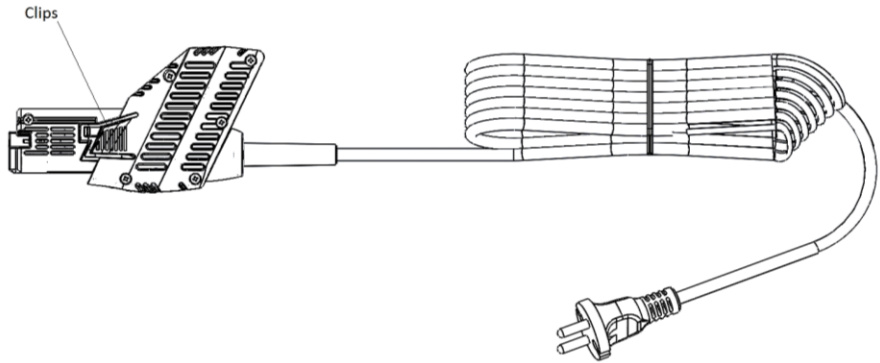

Fig.13

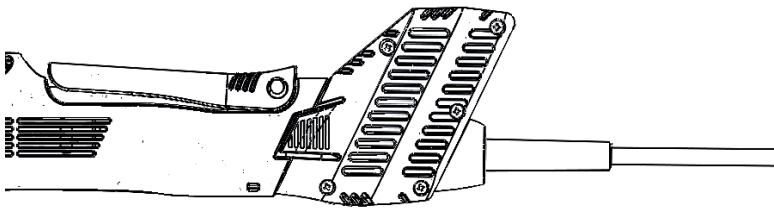

Fig.14

BEFORE STARTING THE TOOL

Ensure that:

- the power supply conforms with the characteristics of the tool (when the tool is used with a power supply 9HP120LT);
- the power supply cable and plug are in perfect condition (when the tool is used with a power supply 9HP120LT);
- the battery pack is in a perfect condition (when the tool is used with a battery pack 9HB120LT) and is charged (see Battery pack lever indication)
- the ON/OFF switch works properly with the power supply 9HP120LT /battery pack 9HB120LT disconnected;
- all the parts of the tool have been assembled in the proper manner and that there are no signs of damage;
- the ventilation slots are not obstructed.

STARTING AND STOPPING

- Starting: rotate the potentiometer knob (2) and set up the speed from 1 to 5 value. Push the switch lever (7) towards the body of the tool.
- Stopping: release the lever and rotate the potentiometer knob until OFF position.

FAILURE TO START

If a tool is failed to start, in a case of:

- 1) *the machine is used with a battery* – assure that the battery pack is charged (see Battery pack lever indication); assure the battery was inserted correctly;
- 2) *the machine is used with a power supply* – check to make sure the prongs on the cord plug are making good contact in the outlet; check if the current is present in the plug. Also, check for blown fuses or open circuit breakers in the line.

TEST RUN



WARNING: if a case of unusual vibration, or dismatching of the buffer pad is present after a start of the tool, switch-off the tool immediately and eliminate the fault.

ELECTRONIC RPM REGULATION

The rpm can be adjusted by rotating the speed regulation Knob (2). The choice of speed depends on the characteristics of the buffers and the material to be worked.

REPLACING THE BUFFER PAD

Before replacing a buffer pad assure that the speed regulation Knob (2) is in OFF position. Pull the used pad off and apply the new one, pressing it onto the disc pad.

ACCESSORIES

 **CAUTION:** Since accessories, other than those offered by Rupes, have not been tested with this product, use of such accessories with this tool could be hazardous. To reduce the risk of injury, only Rupes recommended accessories should be used with this product. Recommended accessories for use with your tool are available at extra cost from your local dealer or authorized service center. If you need assistance in locating any accessory, please visit our website www.rupes.com.

MAINTENANCE AND SERVICING

 **WARNING:** To reduce the risk of injury, turn unit off and disconnect it from power source (when machine is connected to a power supply) or battery pack (when machine is connected to a battery pack) before installing and removing accessories, before adjusting or when making repairs. Be sure the switch is in the “OFF” position. An accidental start-up can cause injury.

CLEANING

 **WARNING:** Blow dirt and dust out of all air vents with clean, dry air at least once a week. To minimize the risk of eye injury, always wear ANSI Z87.1 approved eye protection when performing this.

 **WARNING:** Never use solvents or other harsh chemicals for cleaning the non-metallic parts of the tool. These chemicals may weaken the plastic materials used in these parts. Use a cloth dampened only with water and mild soap. Never let any liquid get inside the tool; never immerse any part of the tool into a liquid.

LUBRICATION

This tool has been lubricated with a sufficient amount of high grade lubricant for the life of the unit under normal operating conditions. No further lubrication is necessary.

REPAIRS

Maintenance and cleaning of the inner parts like ball bearings, gears etc. or others, must be carried out only by an authorized customer service workshop.

RoHS Compliant

This product and the associated component parts are “RoHS Compliant” and do not contain any of the substances in excess of the maximum concentration values in EU RoHS Directive 2011/65/EU and other amendments issued as of the date code marked on the product. Unless otherwise stated by Rupes in writing, this information represents Rupes’s knowledge and belief based on information provided by third party suppliers to Rupes.

WEEE Compliant



At the end of its useful life, this product pursuant to European Directive 2012/19/EU and its implementation in national law, must not be released into the environment or thrown away as domestic waste, but must be disposed of in authorized recycling centers (contact the relevant local authorities for a list of places where the product may be disposed of according to the law).

Disposing of the product correctly contributes to protecting human health and safeguarding the environment.

BATTERY

Rupes BIGFOOT NANO Hybrid tool is equipped with a Li-ion rechargeable battery pack. Any defective or spent batteries should not be disposed as unsorted municipal waste in land fill sites. They should be disposed through the local recommended collection and recycling rules.

Rupes BIGFOOT NANO Hybrid tool Part Numbers:

HR81M – short neck Rupes BIGFOOT NANO Hybrid tool

HR81ML – long neck Rupes BIGFOOT NANO Hybrid tool

9HC120LT – Li-ION Battery Charger

9HB120LT – Li-ION Battery pack

9HP120LT – Rupes BIGFOOT NANO Hybrid tool Power Supply

EC Declaration of conformity

Manufacturers Name: RUPES S.p.A

Manufacturers address: Via Marconi 3A, 20080 Vermezzo (MI) – Italy

Does hereby declare that the machinery described below complies with those applicable essential to health and safety requirements of the Machinery Directive 2006/42/EC, EMC Directive 2004/108/EC, and RoHS Directive 2011/65/EU; together with all amendments to date.

Description: Rupes BIGFOOT NANO Hybrid tool

Model Number: HR81M / HR81ML

Serial Number Range: YYYY MM 0000 - YYYY MM 9999 where the last 4 digits represent the sequential unit manufactured on the date specified in the first 6 numeric characters.

The following standards have either been referred to, or complied with, in full or in part as relevant:

Safety standards:

ISO 12100:2010	Safety of machinery. Basic concepts, general principles for design – Basic terminology and Technical principles
EN 60745-1:2010	Hand-held motor-operated electric tools. Safety. General requirements
EN 60745-2-3:2011	Hand-held motor-operated electric tools. Safety. Particular requirements for grinders, polishers and disk-type sanders
EN 60745-2-4:2009	Hand-held motor-operated electric tools. Safety. Particular requirements for sanders and polishers other than disk type.
EN ISO 14121-1:2007	Safety of machinery. Risk assessment principles
EN ISO 5349-1:2004*	Mechanical vibration. Measurement and evaluation of human exposure to hand-transmitted vibration. General requirements
EN ISO 11202:2010	Acoustics. Noise emitted by machinery and equipment. Measurement of emission sound pressure levels at a workstation and at other specific positions. Survey method in situ.
EN ISO 3744:2010	Acoustics. Determination of sound power levels of noise sources using sound pressure. Engineering

method in an essentially free field over a reflecting plane.

EMC standards:

- | | |
|-------------------|---|
| EN 55014-1:2008 | Electromagnetic compatibility (EMC) Requirements for household appliances, electric tools and similar apparatus, Part 1: Emission |
| EN 61000-3-2:2015 | Electromagnetic compatibility (EMC) Part 3-2: Limits – limits for harmonic current emissions (equipment input current 16 A per phase) |
| EN 61000-3-3:2014 | Electromagnetic compatibility (EMC) Part 3-3: Limits – Limitation of voltage changes, voltage fluctuations and flicker in public low-voltage supply systems, for equipment with rated current 16A per phase and not subjected to conditional connection |
| EN 55014-2:2015 | Electromagnetic compatibility (EMC) Requirements for household appliances, electric tools and similar apparatus, Part 2: Immunity – Product family standard |

* Reduced feed-force; refer to specifications

Full Name of responsible person: Mr. Guido Valentini

Position: President

Signature:

Date:
Vermezzo, Italy

Full name and address of individual responsible to compile technical file within the Community:
Mr. Guido Valentini – President,, Rupes S.p.A. Via Marconi 3A, 20080 Vermezzo (MI) – Italy