

Smartloc 1 nut

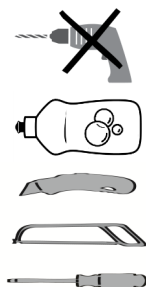

1.

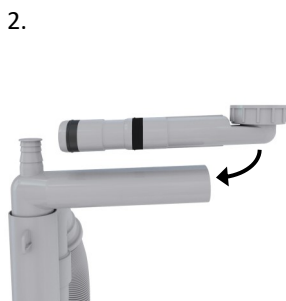
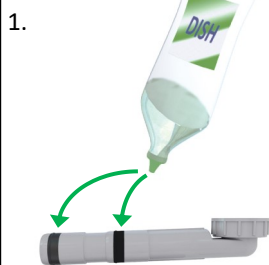

2.

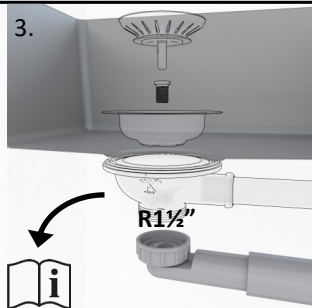
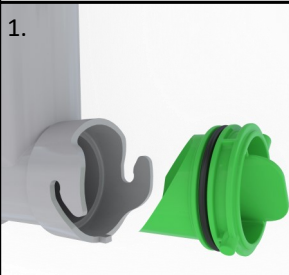

3. A / B?

A1.



A2.

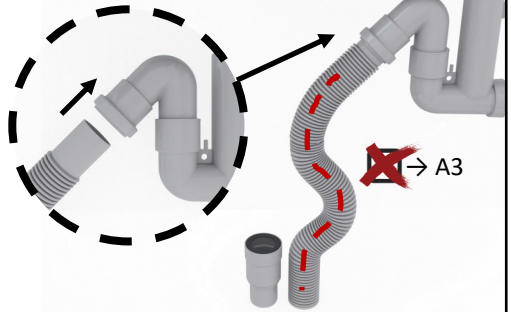

A3.

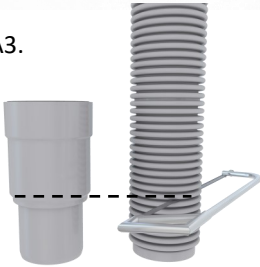

A4.



A5.

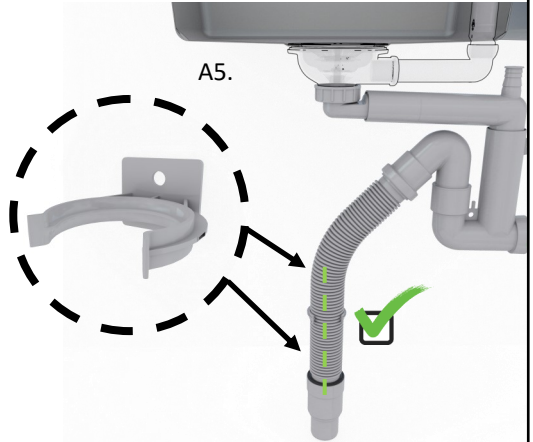

B1 

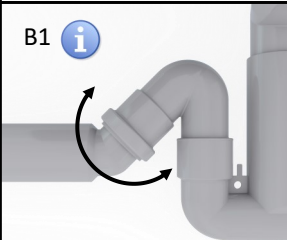

B1 

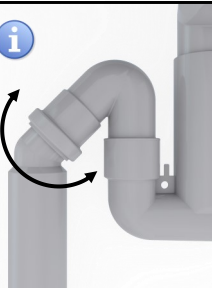

4. TEST

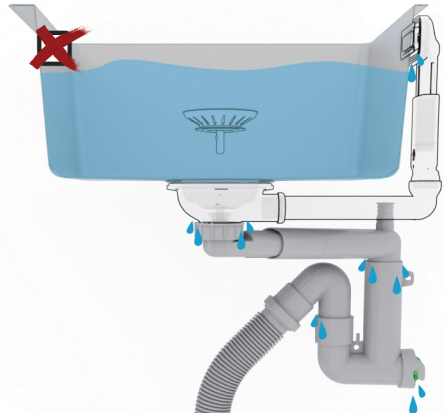
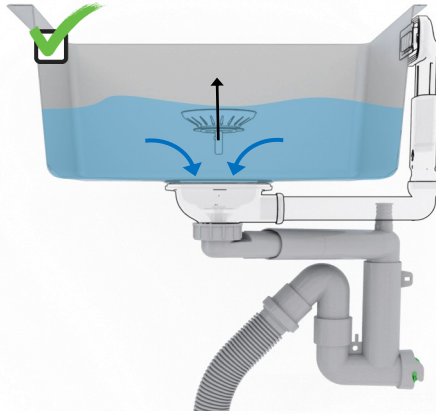

INFO

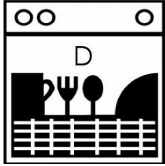

SERVICE

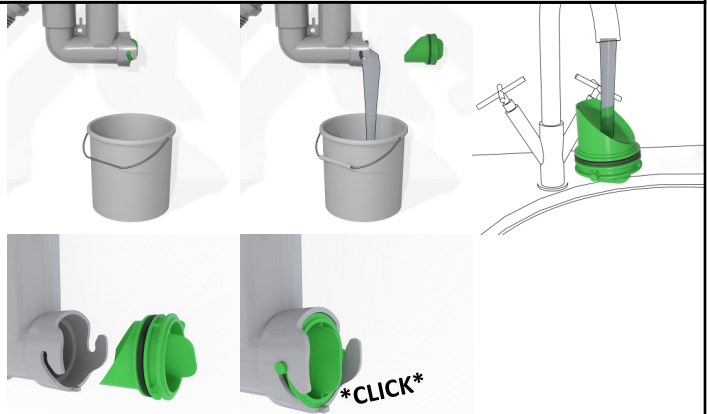

INFO

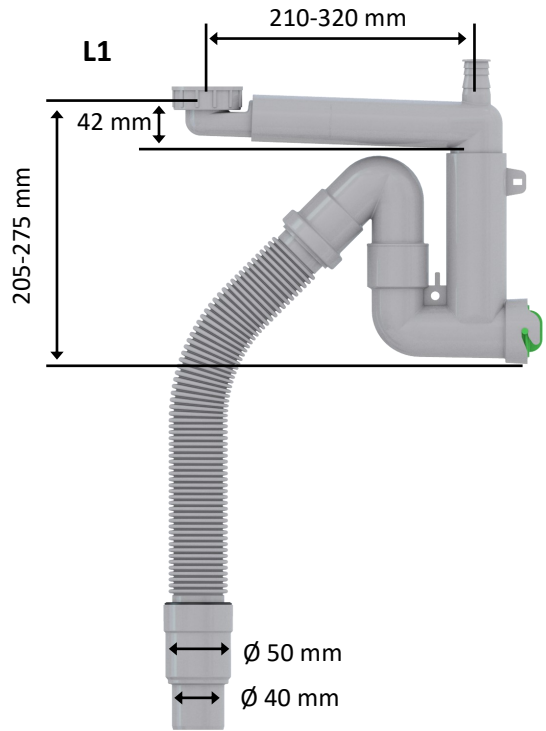

L2 info

